

AMB-2003/2023/2053 Series

Modular System Industrial Panel PCs

Version 1.0

Industrial Panel PCs

Industrial Panel PCs for Industrial Automation

User's Manual

Contents

Chapter1 General Information	1
1.1 Introduction.....	2
1.2 Specifications	3
General.....	3
Environmental.....	3
Rear View picture.....	3
Features	4
Specifications.....	6
Power Supply Selection Table.....	8
1.3 Touchscreen (Optional)	9
1.4 Order Information.....	10
1.5 LCD Specifications	11
1.6 Dimensions	12
1.7 Panel Mounting.....	15
1.8 Packing List	16
Chapter2 MBC-6310 Introduction	14
Checklist.....	15
Description.....	16
Features	17
Specifications	18
Intelligence	20
Board Dimensions	21
Chapter3 MBC-6310 Installations	22
CPU Installation.....	23
Memory Installation.....	24
Jumpers on the MBC-6310.....	25
Jumper Locations on the MBC-6310	26
DSW1 (1-8): CPU Frequency Selector.....	27
JP1: DiskOnChip BIOS Expansion Address Select	28
JP2: Clear CMOS Content	29
JP4: LCD Power Setting	29
Setting	29
Connectors on the MBC-6310	30
Connector Locations on the MBC-6310	31
J1, J2: EIDE Connectors.....	32

J3: Front Bezel Connector	33
JP3: IrDA Connector.....	35
J4: Floppy Drive Connector.....	36
J5: Parallel Port Connector	36
J6: External Keyboard Connector.....	37
J7, J8: COM1/COM2 Serial Ports.....	37
J9: PS/2 Keyboard Connector.....	37
J10: PS/2 Mouse Connector.....	38
J11: VGA CRT Connector.....	38
J12: RJ45 Connector.....	38
J13: External ATX Power Connector	40
J14, J15: LCD Panel Connectors	40
Flat Panel Display Interface Pin Descriptions.....	41
J17, J18: USB Connectors	42
J20: CPU Fan Power Connector.....	42
J21: Chassis Fan Power Connector.....	42
Watchdog Timer Configuration	43
Exploded Diagram.....	44
Cooling Fan Replacement.....	45
Install a 3.5" HDD	46
Install a Slim CD-Rom, FDD and 2.5" HDD	47

1

Chapter1 General Information

<u>1.1</u>	<u>Introduction</u>	2
<u>1.2</u>	<u>Specifications</u>	3
<u>1.3</u>	<u>Touchscreen (Optional)</u>	9
<u>1.4</u>	<u>Order Information</u>	10
<u>1.5</u>	<u>LCD Specifications</u>	11
<u>1.6</u>	<u>Dimensions</u>	12
<u>1.7</u>	<u>Panel Mounting</u>	15
<u>1.8</u>	<u>Packing List</u>	16

1.1 Introduction

The AMB-2003/2023/2053 series modular system panel PCs, is the PC-base industrial computer that specially designed to keep normal operation under harsh environment, which meet the entire requirement as an industrial man machine interface (MMI).

They provide a complete hard ware application and construct a high quality plastic front panel NEMA 4/12 which meets the toughest industrial and environmental protection standards

It is a full-function PC-base system with a 10.4" VGA(640 x 480), 12.1" SVGA (800 x 600), 15.1" XGA (1024 x 768) color TFT hi-brightness, long-life time LCD display, and compact with different control modules via a 50-pin SCSI cable. The compact dimensions are ideal for automation applications when the installation space is critical.

These PCs are characterized by their space saving, there are two free slots for PCI/ ISA. AMB-2003/2023/2053 is heavy-duty steel chassis with a sealed plastic front panel. meets the toughest industrial and environmental standards. All the controls and connectors are placed on the rear panel, you can connect the panel PCs to other devices via them.

1.2 Specifications

General

- **Construction:** Heavy-duty aluminum chassis & NEMA 4/12 plastic or aluminum front panel
- **Disk drive housing:**
a 3.5" HDD or a 2.5" HDD, Slim CD-ROM & Slim FDD.
- **Dimensions(AMB -2003):** 330(W) x 252(H) x 128mm(D)
- **Gross Weight:** 9.6 Kg
- **Dimensions(AMB -2023):** 346(W) x 271(H) x 126mm(D)
- **Gross Weight:** 10 Kg
- **Dimensions(AMB -2053):** 420(W) x 300(H) x 139mm(D)
- **Gross Weight:** 13.6 Kg

Environmental

- **Operating temperature:** 0° to 50°
- **Storage temperature:** -20° to 60°
- **Relative humidity:** 5 to 95%, non-condensing
- **Altitude:** 10,000 ft. (3000 meters)
- **Vibration:**
5 to 17Hz, 0.1" double-amplitude displacement
17 to 500 Hz, 1.5G peak to peak
- **Shock:** 10G-peak acceleration (11-msec. duration)
- **Safety:** meets UL/CSA/TUV
- **EMI:** FCC/CE Class A

Rear View picture

- **NEMA 4/12 plastic front panel**
- **Outside connectors**
- **Drive bay**
- **30 CFM cooling fan**
- **Power switch**
- **Power inlet & fuse**

Features

AMB-2003 (10.4"LCD + ACS-2303 Control Box)

- 10.4" VGA color TFT LCD display
- Heavy-duty steel chassis and NEMA 4/12 compliant plastic front panel
- All-in-one SBC, Intel Celeron 366MHz CPU, 32MB SDRAM, Ethernet, VGA.
- Two 16C550 RS-232C port, two RS-232C port
- Disk Driver Space for CD-ROM, FDD and HDD
- DiskOnChip flash disk socket
- Print Port
- Expansion IDE/Floppy connectors***
- Touch Screen (optional)
- USB port (optional)

***Expansion IDE port will not functional when both HDD & CD-ROM install in the machine

AMB-2023 (12.1"LCD + ACS-2303 Control Box)

- 12.1" SVGA color TFT LCD display
- Heavy-duty steel chassis and NEMA 4/12 compliant plastic front panel
- All-in-one SBC, Intel Celeron 366MHz CPU, 32MB SDRAM, Ethernet, VGA.
- Two 16C550 RS-232C port, two RS-232C port
- Disk Driver Space for CD-ROM, FDD and HDD
- DiskOnChip flash disk socket
- Print Port
- Expansion IDE/Floppy connectors***
- Touch Screen (optional)
- USB port (optional)

***Expansion IDE port will not functional when both HDD & CD-ROM install in the machine

AMB-2053 (15"LCD + ACS-2303 Control Box)

- 15" XGA color TFT LCD display
- Heavy-duty steel chassis and NEMA 4/12 compliant plastic front panel
- All-in-one SBC, Intel Celeron 366MHz CPU, 32MB SDRAM, Ethernet, VGA.
- Two 16C550 RS-232C port, two RS-232C port
- Disk Driver Space for CD-ROM, FDD and HDD
- DiskOnChip flash disk socket
- Print Port
- Expansion IDE/Floppy connectors
- Touch Screen (optional)
- USB port (optional)

***Expansion IDE port will not functional when both HDD & CD-ROM install in the machine

Specifications

AMB-2003 (10.4"LCD + ACS2303 Control Box)

- **Construction:** Heavy-duty steel chassis & NEMA 4/12 plastic front panel.
- **CPU:** Intel Celeron 366MHz
- **Memory:** 32MB SDRAM
- **Display:** 10.4" VGA (640 x 480) TFT color LCD
- **LCD/CRT controller:**
C&T 69000 VGA controller with 2MB embedded SDRAM. CRT & LCD panel support
- **Network (LAN):**
Intel 82558B 10/100 Base-T Ethernet controller
- **I/O ports:**
Win bond W83977
COM1: RS-232
COM2: RS-232
1 parallel port (support ECP/EPP)
1 keyboard port
1 PS/2 mouse interface
Disk Driver Housing:
3.5" HDD or 2.5" HDD and 3.5" FDD or 2.5" HDD and Slim-size CD-ROM
- **USB connector:** Dual USB ports onboard
- **Mounting:** Panel mount or Wall mount (ACS-2303 Control Box only, optional)
- **Power supply:** Universal 70W switching power supply

AMB-2023 (12.1"LCD + ACS2303 Control Box)

- **Construction:** Heavy-duty steel chassis & NEMA 4/12 plastic front panel.
- **CPU:** Intel Celeron 366MHz
- **Memory:** 32MB SDRAM
- **Display:** 12.1" SVGA (800 x 600) TFT color LCD
- **LCD/CRT controller:**
C&T 69000 VGA controller with 2MB embedded SDRAM. CRT & LCD panel support
- **Network (LAN):**
Intel 82558B 10/100 Base-T Ethernet controller
- **I/O ports:**
Win bond W83977
COM1: RS-232
COM2: RS-232
1 parallel port (support ECP/EPP)
1 keyboard port
1 PS/2 mouse interface
Disk Driver Housing:
3.5"HDD or 2.5"HDD and 3.5"FDD or 2.5"HDD and Slim-size CD-ROM
- **USB connector:** Dual USB ports onboard
- **Mounting:** Panel mount or Wall mount (ACS-2303 Control Box only, optional)
- **Power supply:** Universal 70W switching power supply

AMB-2053 (15"LCD + ACS2303 Control Box)

- **Construction:** Heavy-duty steel chassis & NEMA 4/12 plastic front panel.
- **CPU:** Intel Celeron 366MHz
- **Memory:** 32MB SDRAM
- **Display:** 15" XGA (1024 x 768) TFT color LCD
- **LCD/CRT controller:**
C&T 69000 VGA controller with 2MB embedded SDRAM. CRT & LCD panel support
- **Network (LAN):**
Intel 82558B 10/100 Base-T Ethernet controller
- **I/O ports:**
Win bond W83977
COM1: RS-232
COM2: RS-232
1 parallel port (support ECP/EPP)
1 keyboard port
1 PS/2 mouse interface
Disk Driver Housing:
3.5" HDD or 2.5" HDD and 3.5" FDD or 2.5" HDD and Slim-size CD-ROM
- **Disk Driver Housing:**
3.5" HDD or 2.5" HDD and 3.5" FDD or 2.5" HDD and Slim-size CD-ROM
- **USB connector:** Dual USB ports onboard
- **Mounting:** Panel mount or Wall mount (ACS-2303 Control Box only, optional)
- **Power supply:** Universal 70W switching power supply.

Power Supply Selection Table

Mode	Input voltage	Max. Output Current		
		+5V	+12V	-12V
Universal/70W	85-265VAC	12A	2.5A	0.3A
24VDC/70W	10-30VDC	12A	2.5A	0.3A

1.3 Touchscreen (Optional)

- **Type:** 4/8-wire, analog resistive
- **Resolution:** Continuous
- **Light transmission:** 72% (surface 4H, meets ASTM-D-3363-92A standard.)
- **Operating pressure:** <50 grams for finger, <25 grams for stylus pen. Contact bounce < 10ms
- **Controller:** RS-232 interface
- **Power consumption:** +5V @200mA
- **OS support:** MS DOS, Windows 3.1, Windows 95, Windows 98, Windows NT, Windows2000

1.4 Order Information

AMB-2003HT:

10.4" Modular system Industrial Panel PC

AMB-2003HTT:

AMB-2003HT with touchscreen

AMB-2023HT:

12.1" Modular system Industrial Panel PC

AMB-2023HTT:

AMB-2023HT with touchscreen

AMB-2053HT:

15" Modular system Industrial Panel PC

AMB-2053HTT:

AMB-2053HT with touchscreen

1.5 LCD Specifications

Model	AMB-2003	AMB-2023	AMB-2053
Display type	Color TFT LCD	Color TFT LCD	Color TFT LCD
Size (diagonal)	10.4"	12.1"	15"
Number of Pixels	640(W) x 480(H)	800(W) x 600(H)	1024(W) x 768(H)
Dot size (mm x mm)	0.33(W) x 0.33	0.3075(W) x 0.3075	0.313(W) x 0.329(H)
Contrast ratio	250	250	300
View angle (Horizontal)	90°	120°	160°
View angle (Vertical)	50°	100°	160°
Luminance (cd/m ²)	200	250	250
LCD model	NEC AC33-18	Toshiba LTM12C289	Fujitsu FLC3XGC6V-04
Operating Temperature	0 ~ 50 °C	0 ~ 50 °C	0 ~ 50 °C
Backlight Life-time (Hrs)	20,000	25,000	25,000

1.6 Dimensions

AMB-2003HT

Cutout (suggestion)

The AMB-2023 series will stand on a shelf or a table or you can mount it into a panel. Cutout panel dimensions are the following:

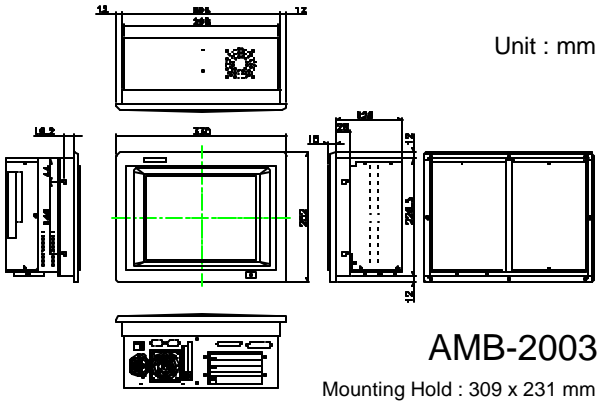

AMB-2023HT

Cutout (suggestion)

The AMB-2023 series will stand on a shelf or a table or you can mount it into a panel. Cutout panel dimensions are the following:

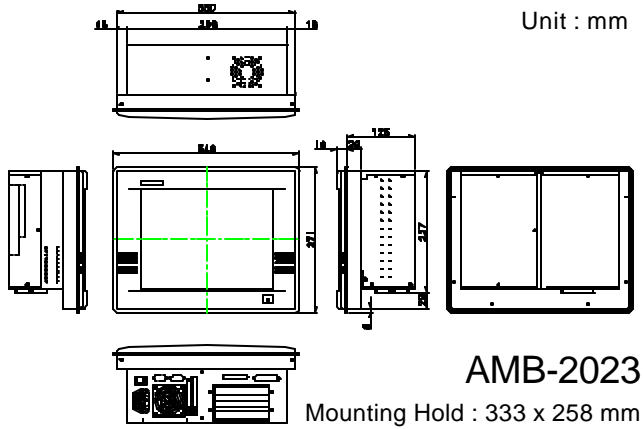

AMB-2053HT

Cutout (suggestion)

The AMB-2023 series will stand on a shelf or a table or you can mount it into a panel. Cutout panel dimensions are the following:

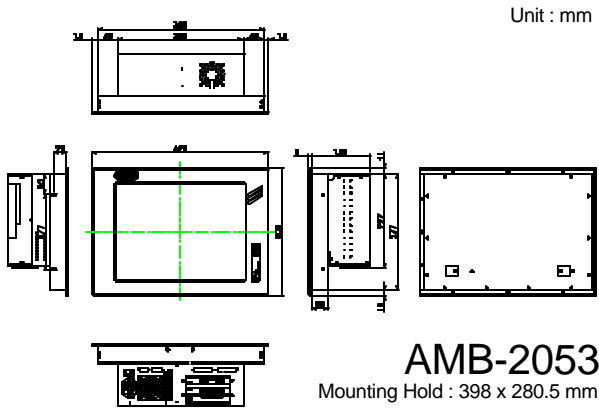

1.7 Panel Mounting

This display panels can be placed on a shelf or table, or mounted onto a control panel. To mount them onto a control panel you need a kind of mounting kits, which you will find in the accessory box. Take the mounting steps described here below:

1. Set the display panel within the aperture in your control panel
2. Slide the mounting kits into the slots on the chassis cover
3. Tighten the bolt in the kits until the display panel is firmly secured to the control

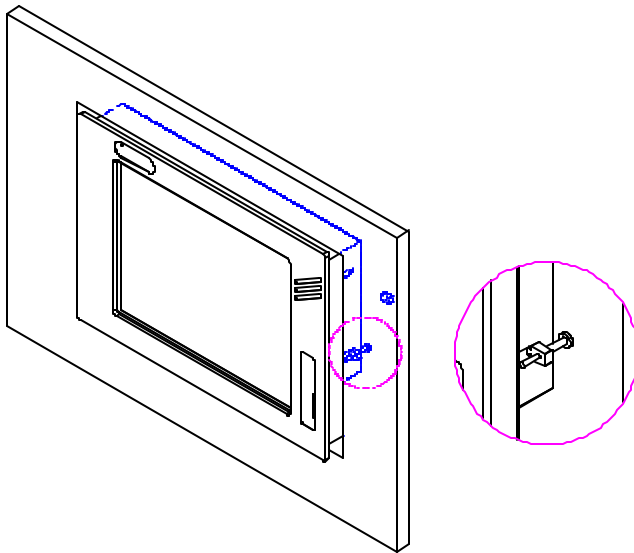

PANEL MOUNTING

1.8 Packing List

Then you should also check if the package contains the following items. You should contact your dealer immediately if any of these items are missing or damaged

- One series industrial MMI panel PC with flat panel display
- Disk for AMB-2003/2023/2053 series user's manual
- CI7BP (MBC-6310) user's manual
- Utility & Driver Disks: 3Pcs
 - VGA Driver for Windows 95/ 98/ NT4.0
 - Intel 82558B Driver Disk 1
 - Intel 82558B Driver Disk 2
- Accessory
 - Plane for extension solution
 - Power cable for HDD & FDD
 - Screws bag
 - SCSI Cable (1M)
 - Power cord (1.8 M)
 - Assembly mounting parts

If any of their items are missing or damaged, contact your distributor or sales representative immediately.

2

Chapter2 MBC-6310 Introduction

This manual is designed to give you information on the MBC-6310 CPU card. It is divided into the following sections:

Checklist.....	15
Description	16
Features	17
Specifications.....	18
Intelligence	20
Board Dimensions	21

The topics covered in this chapter are as follows:

- ◆ Checklist
- ◆ Description
- ◆ Features
- ◆ Specifications
- ◆ Layout of Key Components and Dimensions

Checklist

Please check that your package is complete and contains the items below. If you discover damaged or missing items, please contact your dealer.

- The MBC-6310 Industrial CPU Card
- This User's Manual
- 1 Diskette containing Intel PCI IDE Driver and Flash Memory Utility
- 2 Diskettes containing C&T 69000 VGA Driver
- 2 Diskettes containing Intel 82558B LAN Driver
- 1 Diskette containing System Monitor utility

Description

The MBC-6310 is a Pentium II Industrial CPU card based on the Intel 440BX chipset and is fully designed for harsh industrial environment. It features a Socket-370 processor connector that is compatible with Intel Celeron processors. This card accommodates up to 256MB SDRAM configuration.

The MBC-6310 comes with Winbond's W83781D hardware monitoring device that monitors system and CPU temperature, system voltages, and CPU and chassis fan speeds to prevent system crashes by warning the user of adverse conditions. The power management feature provides power savings by slowing down the CPU clock, turning off the monitor screen and stopping the HDD spindle motor.

Features

- CPU Speed 300~850MHz, Intel Celeron, Coppermine processors
- Bus Speed 66MHz/100MHz
- Intel 440BX AGPset
- Up to 256 SDRAM system memory
- C&T 69000 VGA chipset for LCD & CRT displays
- Two RS-232 serial ports
- 16 level programmable watchdog timer, from 0-30 seconds
- High speed bi-directional SPP/ECP/EPP parallel port
- Hardware Monitoring, Win95 shut-off, Modem ring-on
- 10/100M Base-T Ethernet interface, Novell NE2000 Compatible

Specifications

- **Processor Socket:** Socket 370 connector
- **Processor:** Intel Celeron/Coppermine 300~850MHz
- **Bus Speed:** 66MHz and 100MHz
- **Chipset:** Intel 440BX AGPset with PCI EIDE and RTC built-in
- **Secondary Cache:** CPU integrated
- **Memory Socket:**
 - One 168-pin DIMM socket
 - Max. 256MB SDRAM
 - Memory type: SDRAM (Synchronous DRAM)
- **BIOS:** Award BIOS, PnP support
 - FLASH EEPROM (256KB) for BIOS update
 - ISA Plug and Play (PnP) extension
 - Power management
- **DMI BIOS Support:**

Desktop Management Interface (DMI) allows users to download system hardware-level information such as CPU type, CPU speed, internal/external frequencies and memory size.
- **Multi I/O:** Winbond W83977TF
- **Parallel Port:** One high-speed parallel port, SPP/EPP/ECP mode
- **Serial Port:** Two 16550 UART compatible ports configurable as RS232
- **Enhanced IDE:** Two Bus Mastering EIDE mode, up to 4 devices, Two EIDE interfaces for up to four devices, support PIO Mode 3/4 or Ultra DMA/33 IDE Hard Disk and ATAPI CD-ROM.
- **FDD Interface:** Two floppy drives (360KB, 720KB, 1.2MB, 1.44MB, 2.88MB, LS-120)
- **CRT/LCD:** C&T 69000 chipset
 - Embedded 2MB SDRAM display memory
 - Simultaneous CRT & LCD display
 - LCD panel supports DSTN/TFT
 - 1280x1024x8bpp colors CRT resolution
 - Up to 1280x1024x8bpp colors resolution for color active matrix TFT panels (12, 18, and 24bit analog) or (12+12), (18+18) double pixel/CLK interface

- **USB Interface:** Two USB pin-header connectors, compliant with USB Specification Rev. 1.0
- **DiskOnChip:** The M-Systems flask disk supports system boot and storage capacity from 2MB to 72MB.
- **Watchdog Timer:** 16-level, programmable
 - I/O port 0443H to enable watchdog.
 - I/O port 0441H to disable watchdog.
 - Time-out timing select 0/2/4/6/8/10/12/14/16/18/20/22/24/26/28/30 seconds (+/-20%).
- **Green Function:** Power management via BIOS, activated through mouse/keyboard movement
- **PCI Bus Ethernet Interface:** Intel 82558B chipset
 - PCI local bus Ethernet controller
 - Supports IEEE802.3u auto-negotiation for automatic speed selection
 - support 10/100Mbps operation in a single port PCI bus master architecture
- **Keyboard and Mouse Connectors:** PS/2 type mini-DIN that supports PC/AT; supports a 5-pin external keyboard connector
- **IrDA Interface:** Pin-header connector for the optional IrDA external connector
- **Environmental and Mechanical:**
 - **Power Supply:** 10A @+5V(max), ±12V:100mA(max)
 - **Temperature:** 0°C to 60°C
 - **Humidity:** 5% to 95%
 - **Dimensions:** 185mm x 129mm (7.3" x 5.0")

Intelligence

- **Temperature Monitoring and Alert:** A sensor for the CPU temperature on the MBC-6310 monitors the CPU temperature and alerts the user through the speaker or buzzer when temperature exceeds the safe heat level.
- **Windows 95 shut-off:** Allows shut-off control from within Windows 95 and through an ATX power supply.
- **Modem ring-on:** Allows system powering on through an external modem and through an ATX power supply.
- **Year 2000 Compliant BIOS:** The onboard Award BIOS is Year 2000 Compliant and will pass software applications that have the tendency to invoke INT1AH function 04H such as year2000.exe utility released by NSTL.
- **Wake On LAN:** Through an ATX power supply and network connection, systems can be turned on from the power-off state.

Board Dimensions

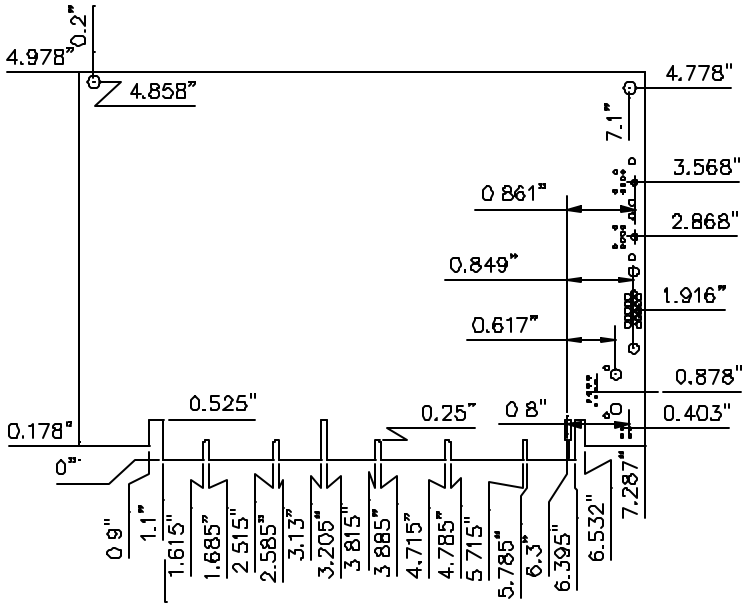

3

Chapter3 MBC-6310 Installations

This chapter provides information on how to use the jumpers and connectors on the MBC-6310 in order to set up a workable system. The topics covered are:

CPU Installation	23
Memory Installation	24
Jumpers on the MBC-6310	25
Connectors on the MBC-6310	30
Watchdog Timer Configuration	43

CPU Installation

The MBC-6310 Industrial CPU Card supports a Socket 370 connector processor socket for Intel Celeron processors.

The Socket 370 connector uses a standard PGA socket connector. To install the CPU, insert it to the socket by aligning the notch of the Socket 370 CPU with the one of the PGA socket.

After you have installed the processor into place, check if the jumper setting for the CPU speed is correct.

NOTE: *Ensure that the CPU heat sink and the CPU top surface are in total contact to avoid CPU overheating problem that would cause your system to hang or be unstable.*

Memory Installation

The MBC-6310 Industrial CPU Card supports one 168-pin DIMM socket for a maximum total memory of 256MB. The memory module can come in sizes of 16MB, 32MB, 64MB, 128MB and 256MB SDRAMs.

Installing and Removing DIMMs

To install the DIMM module, locate the memory slot on the MBC-4860 and perform the following steps:

1. Hold the DIMM so that the two keys of the DIMM align with those on the memory slot.
2. Gently push the DIMM in an upright position until the clips of the slot close to hold the DIMM in place when the DIMM touches the bottom of the slot.
3. To remove the DIMM, press the clips with both hands.

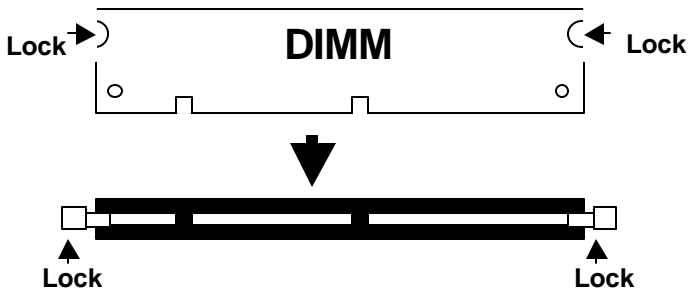

Top View of DIMM Socket

Jumpers on the MBC-6310

The jumpers on the MBC-6310 allow you to configure your CPU card according to the needs of your applications. If you have doubts about the best jumper configuration for your needs, contact your dealer or sales representative. The following table lists the connectors on MBC-6310 and their respective functions.

Jumper Locations on the MBC-6310.....	26
DSW1 (1-8): CPU Frequency Selector.....	27
JP1: DiskOnChip BIOS Expansion Address Select.....	28
JP2: Clear CMOS Content.....	29
JP4: LCD Power Setting	29
S1: LCD Type Selector.....	29

NOTE: Jumper J19 is for manufacturer testing use only.

Remarks: The following conventions are used in this section:

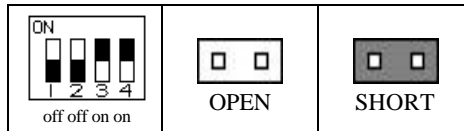



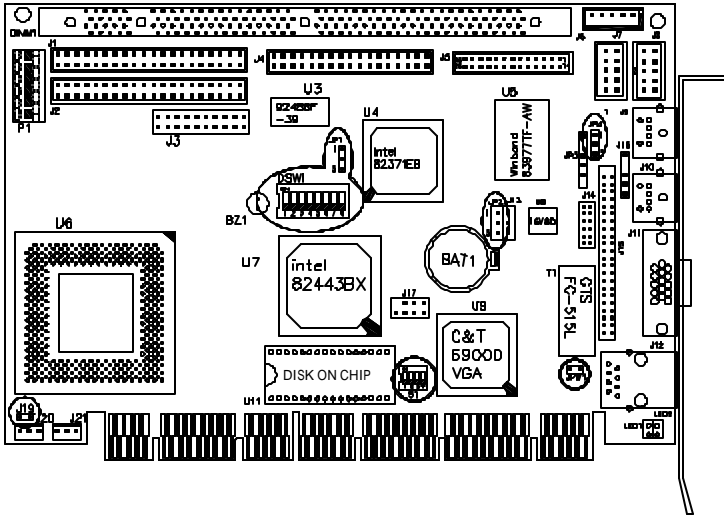



Jumper Locations on the MBC-6310



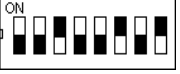



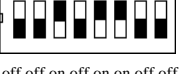

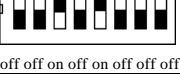
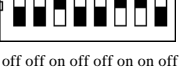
NOTE: Jumper J19 is for manufacturer testing use only.



DSW1 (1-8): CPU Frequency Selector

The table below shows the correct setting to match the CPU frequency.

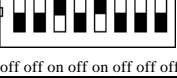
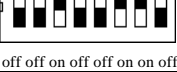

CPU Type	CPU Frequency	DSW1(1-8)
Celeron 66MHz Host Clock CPU	4.5x 66MHz 300MHz	 off off on off off on off on
	5x 66MHz 333MHz	 off off on off off on on on
	5.5x 66MHz 366MHz	 off off off off off off on on
	6x 66MHz 400MHz	 off off on on on on on off
	6.5x 66MHz 433MHz	 off off on on on on off off
	7x 66MHz 466MHz	 off off on on on on off off
	7.5x 66MHz 500MHz	 off off on on on off off off
	8x 66MHz 533MHz	 off off on off on on on off

CPU Type	CPU Frequency	DSW1(1-8)
Coppermine 100MHz Host Clock CPU	4.5x 100MHz 450MHz	 off off on off off on off on
	5x 100MHz 500MHz	 off off on off off off on on
	5.5x 100MHz 550MHz	 off off off off off off on on
	6x 100MHz 600MHz	 off off on on on on on off
	6.5x 100MHz 650MHz	 off off on on on on off off
	7x 100MHz 700MHz	 off off on on on off off off
	7.5x 100MHz 750MHz	 off off on on on off off off
	8x 100MHz 800MHz	 off off on off off on on off

JP1: DiskOnChip BIOS Expansion Address Select



JP1	Address
	D0000-D7FFF
	D8000-DFFFF (default)

JP2: Clear CMOS Content

JP2	Setting	Function
	Pin 2-3 Short/Closed	Clear CMOS Content
	Pin 1-2 Short/Closed	Normal Operation

JP4: LCD Power Setting

The MBC-6310 XGA interface supports 5V and 3.3V LCD displays. Use JP4 to change between 5V (*default*) and 3.3V panel video signal level.

JP4	Setting
	5V (default)
	3.3V

Connectors on the MBC-6310

The connectors on the MBC-6310 allows you to connect external devices such as keyboard, floppy disk drives, hard disk drives, printers, etc. The following table lists the connectors on MBC-6310 and their respective functions.

Connector Locations on the MBC-6310.....	31
J1, J2: EIDE Connectors	32
J3: Front Bezel Connector.....	33
JP3: IrDA Connector	35
J4: Floppy Drive Connector.....	36
J5: Parallel Port Connector.....	36
J6: External Keyboard Connector.....	37
J7, J8: COM1/COM2 Serial Ports	37
J9: PS/2 Keyboard Connector.....	37
J10: PS/2 Mouse Connector.....	38
J11: VGA CRT Connector.....	38
J12: RJ45 Connector	38
J13: External ATX Power Connector.....	40
J14, J15: LCD Panel Connectors	40
J17, J18: USB Connectors	42
J20: CPU Fan Power Connector.....	42
J21: Chassis Fan Power Connector.....	42

Connector Locations on the MBC-6310

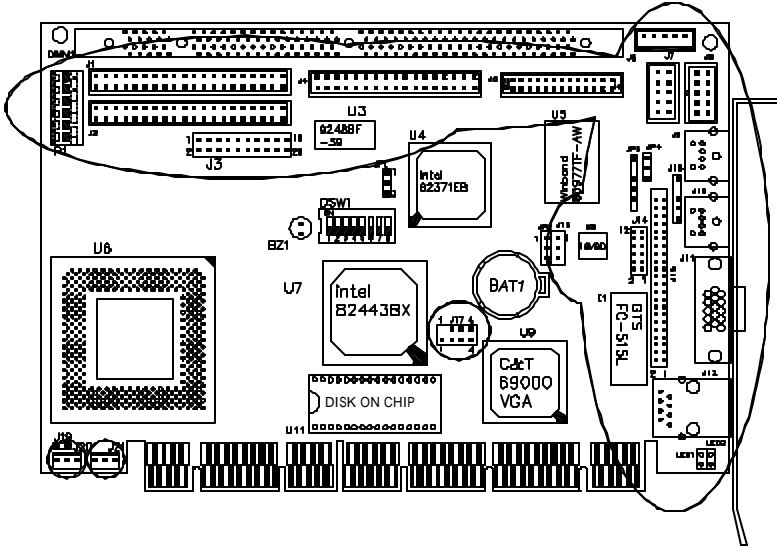

J1, J2: EIDE Connectors

J1: Primary IDE Connector

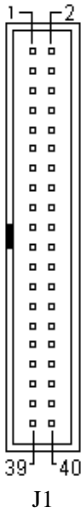

Signal Name	Pin #	Pin #	Signal Name
Reset IDE	1	2	Ground
Host data 7	3	4	Host data 8
Host data 6	5	6	Host data 9
Host data 5	7	8	Host data 10
Host data 4	9	10	Host data 11
Host data 3	11	12	Host data 12
Host data 2	13	14	Host data 13
Host data 1	15	16	Host data 14
Host data 0	17	18	Host data 15
Ground	19	20	Key
DRQ0	21	22	Ground
Host IOW	23	24	Ground
Host IOR	25	26	Ground
IOCHRDY	27	28	Host ALE
DACK0	29	30	Ground
IRQ14	31	32	No connect
Address 1	33	34	No connect
Address 0	35	36	Address 2
Chip select 0	37	38	Chip select 1
Activity	39	40	Ground

J2: Secondary IDE Connector

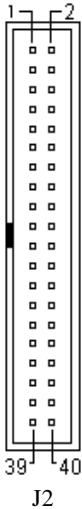

Signal Name	Pin #	Pin #	Signal Name
Reset IDE	1	2	Ground
Host data 7	3	4	Host data 8
Host data 6	5	6	Host data 9
Host data 5	7	8	Host data 10
Host data 4	9	10	Host data 11
Host data 3	11	12	Host data 12
Host data 2	13	14	Host data 13
Host data 1	15	16	Host data 14
Host data 0	17	18	Host data 15
Ground	19	20	Key
DRQ1	21	22	Ground
Host IOW	23	24	Ground
Host IOR	25	26	Ground
IOCHRDY	27	28	Host ALE
DACK1	29	30	Ground
IRQ15	31	32	No connect
Address 1	33	34	No connect
Address 0	35	36	Address 2
Chip select 0	37	38	Chip select 1
Activity	39	40	Ground

J3: Front Bezel Connector

The front bezel of the case has a control panel that provides light indication of the computer activities and switches to change the computer status. J1 is a 20-pin header that provides interfaces for the following functions.

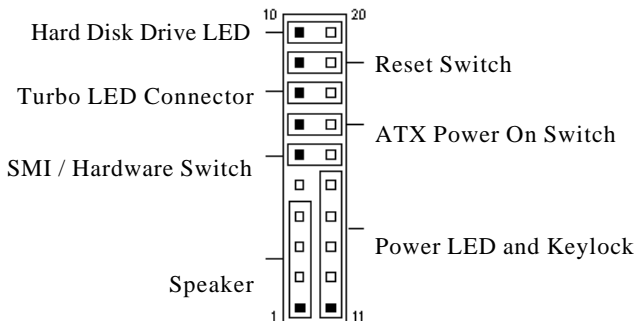

Speaker: Pins 1 - 4

This connector provides an interface to a speaker for audio tone generation. An 8-ohm speaker is recommended.

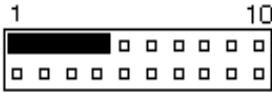

Pin #	Signal Name
1	Speaker out
2	No connect
3	Ground
4	+5V

Power LED and Keylock: Pins 11 - 15

The power LED indicates the status of the main power switch. The keylock switch, when closed, will disable the keyboard function.

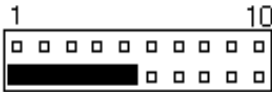

Pin #	Signal Name
11	Power LED
12	No connect
13	Ground
14	Keylock
15	Ground

SMI/Hardware Switch: Pins 6 and 16

This connector supports the "Green Switch" on the control panel, which, when pressed, will force the system into the power-saving mode immediately.

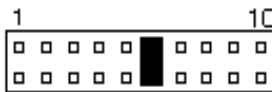

Pin #	Signal Name
6	Sleep
16	Ground

ATX Power ON Switch: Pins 7 and 17

This 2-pin connector is an "ATX Power Supply On/Off Switch" on the system that connects to the power switch on the case. When pressed, the power switch will force the system to power on. When pressed again, it will force the system to power off.



Turbo LED Connector: Pins 8 and 18

There is no turbo/deturbo function on the CPU card. The Turbo LED on the control panel will always be On when attached to this connector.

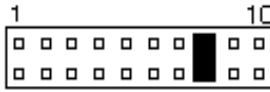

Pin #	Signal Name
8	5V
18	Ground

Reset Switch: Pins 9 and 19

The reset switch allows the user to reset the system without turning the main power switch off and then on again. Orientation is not required when making a connection to this header.

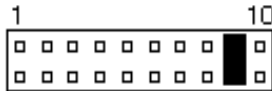
**Hard Disk Drive LED Connector: Pins 10 and 20**

This connector connects to the hard drive activity LED on control panel. This LED will flash when the HDD is being accessed.

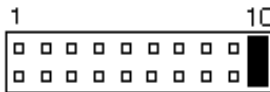

Pin #	Signal Name
10	Ground
20	5V

JP3: IrDA Connector

This connector is used for an IrDA connector for wireless communication.

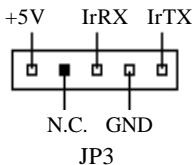

Pin #	Signal Name
1	+5V
2	No connect
3	IrRX
4	Ground
5	IrTX

J4: Floppy Drive Connector

J4 is a 34-pin header and will support up to 2.88MB floppy drives.

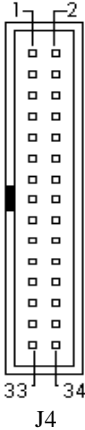

Signal Name	Pin #	Pin #	Signal Name
Ground	1	2	RM/LC
Ground	3	4	No connect
Ground	5	6	No connect
Ground	7	8	Index
Ground	9	10	Motor enable 0
Ground	11	12	Drive select 1
Ground	13	14	Drive select 0
Ground	15	16	Motor enable 1
Ground	17	18	Direction
Ground	19	20	Step
Ground	21	22	Write data
Ground	23	24	Write gate
Ground	25	26	Track 00
Ground	27	28	Write protect
Ground	29	30	Read data
Ground	31	32	Side 1 select
Ground	33	34	Diskette change

J5: Parallel Port Connector

The following table describes the pin out assignments of this connector.

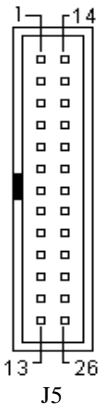

Signal Name	Pin #	Pin #	Signal Name
Line printer strobe	1	14	AutoFeed
PD0, parallel data 0	2	15	Error
PD1, parallel data 1	3	16	Initialize
PD2, parallel data 2	4	17	Select
PD3, parallel data 3	5	18	Ground
PD4, parallel data 4	6	19	Ground
PD5, parallel data 5	7	20	Ground
PD6, parallel data 6	8	21	Ground
PD7, parallel data 7	9	22	Ground
ACK, acknowledge	10	23	Ground
Busy	11	24	Ground
Paper empty	12	25	Ground

Select	13	N/A	N/A
--------	----	-----	-----

J6: External Keyboard Connector

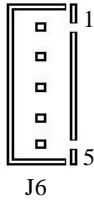

Pin #	Signal Name
1	Keyboard clock
2	Keyboard data
3	NC
4	GND
5	Vcc

J7, J8: COM1/COM2 Serial Ports

J7 and J8, 10-pin header connectors, are the onboard serial ports of MBC-6310. The following table shows the pin assignments of this connector.

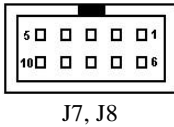

Pin #	Signal Name
1	DCD, Data carrier detect
2	RXD, Receive data
3	TXD, Transmit data
4	DTR, Data terminal ready
5	GND, ground
6	DSR, Data set ready
7	RTS, Request to send
8	CTS, Clear to send
9	RI, Ring indicator
10	NC

J9: PS/2 Keyboard Connector

Pin #	Signal Name
1	Keyboard data
2	N.C.
3	GND

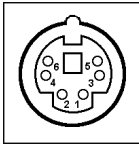

J9

4	5V
5	Keyboard clock
6	N.C.

J10: PS/2 Mouse Connector

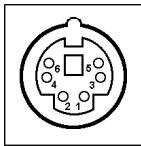

J10

Pin #	Signal Name
1	Mouse data
2	N.C.
3	N.C.
4	5V
5	Mouse Clock
6	N.C.

J11: VGA CRT Connector

The pin assignments of the J11 VGA CRT connector are as follows:

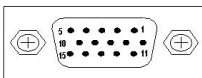

J11

Signal Name	Pin	Pin	Signal Name
Red	1	2	Green
Blue	3	4	N.C.
GND	5	6	GND
GND	7	8	GND
N.C.	9	10	GND
N.C.	11	12	N.C.
HSYNC	13	14	VSYNC
NC	15		

J12: RJ45 Connector

This connector is for the 10/100Mbps Ethernet capability of the CPU card. The figure below shows the pin out assignments of this connector and its corresponding input jack.

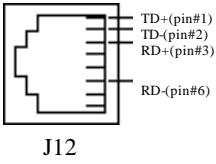

J13: External ATX Power Connector

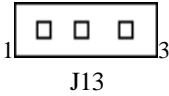

Pin #	Signal Name
1	GND
2	PS-ON (soft on/off)
3	5V SB (standby +5V)

J14, J15: LCD Panel Connectors

J14 and J15 are pin headers for flat panel LCD displays. The following shows the pin assignments of this connector.

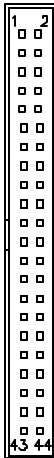

Signal Name	Pin #	Pin #	Signal Name
+12V	1	2	+12V
GND	3	4	GND
5V/3.3V	5	6	5V/3.3V
ENAVEE	7	8	GND
P0	9	10	P1
P2	11	12	P3
P4	13	14	P5
P6	15	16	P7
P8	17	18	P9
P10	19	20	P11
P12	21	22	P13
P14	23	24	P15
P16	25	26	P17
P18	27	28	P19
P20	29	30	P21
P22	31	32	P23
GND	33	34	GND
SHFCLK	35	36	FLM
MDE	37	38	LP
GND	39	40	ENABKL
GND	41	42	LCDVDD
DNAVDD	43	44	5V/3.3V

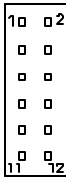

J14

Signal Name	Pin #	Pin #	Signal Name
P24	1	2	P25
P26	3	4	P27
P28	5	6	P29
P30	7	8	P31
P32	9	10	P33
P34	11	12	P35

Flat Panel Display Interface Pin Descriptions

	Mono	Mono	Mono	Color	Color	Color	Color	Color	Color	Color	Color	Color
	SS	DD	DD	TFT	TFT	TFT	TFT	TFT+HR	STN-SS	STN-SS	STN-DD	STN-DD
Pin Name	8-bit	8-bit	16-bit	12/16 bit	18/24 bit	36-bit	18/24 bit	8-bit (4bP)	16-bit (4bP)	8-bit (4bP)	16-bit (4bP)	24-bit
P0	D0	UD3	UD7	B0	B0	FB0	FB0	R1	R1	UR1	UR0	UR0
P1	D1	UD2	UD6	B1	B1	FB1	FB1	B1	G1	UG1	UG0	UG0
P2	D2	UD1	UD5	B2	B2	FB2	FB2	G2	B1	UB1	UB0	UB0
P3	D3	UD0	UD4	B3	B3	FB3	FB3	B3	R2	UR2	UR1	LR0
P4	D4	LD3	UD3	B4	B4	FB4	SB0	G4	G3	LR1	LR0	LG0
P5	D5	LD2	UD2	G0	B5	FB5	SB1	R5	B2	LG1	LG0	LB0
P6	D6	LD1	UD1	G1	B6	SB0	SB2	B5	R3	LB1	LB0	UR1
P7	D7	LD0	UD0	G2	B7	SB1	B3		G3	LR2	LR1	UG1
P8			LD7	G3	G0	SB2	FG0		B3		UG1	UB1
P9			LD6	G4	G1	SB3	FG1		R4		UB1	LR1
P10			LD5	G5	G2	SB4	FG2		G4		UR2	LG1
P11			LD4	R0	G3	SB5	FG3		B4		UG2	LB1
P12			LD3	R1	G4	FG0	SG0		R5		LG1	UR2
P13			LD2	R2	G5	FG1	SG1		G5		LB1	UG2
P14			LD1	R3	G6	FG2	SG2		B5		LR2	UB2
P15			LD0	R4	G7	FG3	SG3		G6		LG2	LR2
P16					R0	FG4	FR0					LG2
P17					R1	FG5	FR1					LB2
P18					R2	SG0	FR2					UR3
P19					R3	SG1	FR3					UG3
P20					R4	SG2	SR0					LR3
P21					R5	SG3	SR1					LG3
P22					R6	SG4	SR2					LB3
P23					R7	SG5	SR3					
P24						FR0						
P25						FR1						
P26						FR2						
P27						FR3						
P28						FR4						
P29						FR5						
P30						SR0						
P31						SR1						
P32						SR2						
P33						SR3						
P34						SR4						
P35						SR5						
SHFCLK	SHFCLK	SHFCLK	SHFCLK	SHFCLK	SHFCLK	SHFCLK	SHFCLK	SHFCLK	SHFCLK	SHFCLK	SHFCLK	SHFCLK
Pixels/Clk:	8	8	16	1	1	2	2	2-2/3	5-1/3	2-2/3	5-1/3	8

J17, J18: USB Connectors

The following table shows the pin outs of the USB connectors.

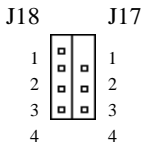

J18 Pin #	J17 Pin #	Signal Name
1	1	Vcc
2	2	USB-
3	3	USB+
4	4	Ground

J20: CPU Fan Power Connector

J20 is a 3-pin header for the CPU fan power. The fan must be a 12V fan.

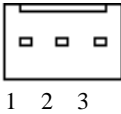

Pin #	Signal Name
1	Rotation
2	+12V
3	Ground

J21: Chassis Fan Power Connector

J21 is a 3-pin header for the chassis fan power. The fan must be a 12V fan.

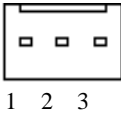

Pin #	Signal Name
1	Rotation
2	+12V
3	Ground

Watchdog Timer Configuration

The function of the watchdog timer is to reset the system automatically and is defined at I/O port 0443H. To enable the watchdog timer and allow the system to reset, write I/O port 0443H. To disable the timer, write I/O port 0441H for the system to stop the watchdog function. The timer has a tolerance of 20% for its intervals.

The following describes how the timer should be programmed.

Enabling Watchdog:

```
MOV  AX, 000FH (Choose the values from 0)
MOV  DX, 0443H
OUT  DX, AX
```

Disabling Watchdog

```
MOV  AX, 00FH (Any value is fine.)
MOV  DX, 0441H
OUT  DX, AX
```

WATCHDOG TIMER CONTROL TABLE

Level	Value	Time/sec	Level	Value	Time/sec
1	F	0	9	7	16
2	E	2	10	6	18
3	D	4	11	5	20
4	C	6	12	4	22
5	B	8	13	3	24
6	A	10	14	2	26
7	9	12	15	1	28
8	8	14	16	0	30

Exploded Diagram

The Award BIOS (Basic Input/Output System) installed in your system's ROM supports NS Geode processors in a standard IBM-AT compatible I/O system. The BIOS provides critical low-level support for standard devices such as disk drives, parallel port and serial ports. It also adds virus and password protection, as well as special support for detailed fine-tuning of the chipset controlling the entire system.

Cooling Fan Replacement

To Service or replace the cooling fan need to remove the rear protective cover and use this diagram as a guide when assembling and disassembling your cooling fan

Install a 3.5" HDD

To installing a 3.5" HDD into AMB-2000HT/2020HT

1. Remove the rear protective cover
2. Place the HDD in the appropriate location and tighten the screws
3. Connect the cable form HDD to the PC board.

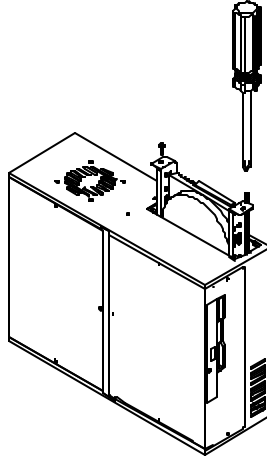

Install a Slim CD-Rom, FDD and 2.5" HDD

To installing a slim FDD & CD-ROM into AMB-2023HT/2053HT

1. Remove the rear protective cover
2. Place the FDD & CD-ROM in the appropriate location and tighten the screws
3. Connect the cable form HDD to the PC board.

