

AMB-2021/2051series
Modular System Industrial Panel PCs
Version 1.1 Beta

Industrial Panel PCs
Industrial Panel PCs for Industrial Automation
User's Manual

Copyright Notice

This publication is protected by copyright and all rights are reserved. No part of it may be reproduced or transmitted by any means or in any form, without prior consent of the original manufacturer.

The information in this document has been carefully checked and is believed to be accurate. However, the original manufacturer assumes no responsibility for any inaccuracies that may appear in this manual. In no event will the original manufacturer be liable for direct, indirect, special, exemplary, incidental, incidental or consequential damages resulting from any defect or omission in this manual, even if advised of possibility of such damages. The material contained herein is for informational purposes only.

Acknowledgments

Award is a registered trademark of Award Software International, Inc.

C&T is a trademark of Chips and Technologies, Inc.

IBM, PC/AT, PS/2 are trademarks of International Business Machines Corporation.

Intel and Pentium are registered trademarks of Intel Corporation.

Microsoft Windows is a registered trademark of Microsoft Corporation.

Winbond is a registered trademark of Winbond Electronics Corporation.

All other product names or trademarks are properties of their respective owners.

Contents

Copyright Notice	ii
1 Introduction	1
1.1 Introduction	2
1.2 Specifications	3
1.3 Touchscreen (Optional)	7
1.4 Order Information	7
1.5 LCD Specifications	8
1.6 Dimensions	9
1.7 Panel Mounting	11
1.8 Packing List	12
2 EI7BM SBC Introduction.....	13
2.1 Checklist.....	14
2.2 Description	14
2.3 Features	14
2.4 Specifications	15
2.5 Board Dimensions	16
3 Hardware Installations	17
3.1 CPU Installation	18
3.2 Memory Installation.....	19
3.3 Jumpers on the EI7BM.....	20
3.4 Connectors on the EI7BM.....	26

1 Introduction

1.1 Introduction

The AMB-2021/2051 series modular system panel PCs, is the PC-base industrial computer that specially designed to keep normal operation under harsh environment, which meet the entire requirement as an industrial man machine interface (MMI).

They provide a complete hard ware application and construct a high quality plastic front panel NEMA 4/12 which meets the toughest industrial and environmental protection standards

It is a full-function PC-base system with a 12.1” SVGA (800 x 600), 15.1” XGA (1024 x 768) color TFT hi-brightness, long-life time LCD display, and compact with different control modules via a 50-pin SCSI cable. The compact dimensions are ideal for automation applications when the installation space is critical.

These PCs are characterized by their space saving, there are two free slots for PCI/ ISA. AMB-2021/2051 is heavy-duty steel chassis with a sealed plastic front panel. meets the toughest industrial and environmental standards. All the controls and connectors are placed on the rear panel, you can connect the panel PCs to other devices via them.

1.2 Specifications

General

- **Construction:** Heavy-duty aluminum chassis & NEMA 4/12 plastic or aluminum front panel
- **Disk drive housing:**
a 3.5" HDD and CD-ROM or a 2.5" HDD, Slim CD-ROM & Slim FDD.
- **Dimensions (AMB-2021):** 330(W) x 255(H) x 126mm(D)
- **Gross Weight:** 7.5 Kg
- **Dimensions (AMB-2051):** 395(W) x 277(H) x 134mm(D)
- **Gross Weight:** 12.5 Kg

Environmental

- **Operating temperature:** 0° to 50°
- **Storage temperature:** -20° to 60°
- **Relative humidity:** 5 to 95%, non-condensing
- **Altitude:** 10,000 ft. (3000 meters)
- **Vibration:**
5 to 17Hz, 0.1" double-amplitude displacement
17 to 500 Hz, 1.5G peak to peak
- **Shock:** 10G-peak acceleration (11-msec. duration)
- **Safety:** meets UL/CSA/TUV
- **EMI:** FCC/CE Class A

Rear View

- **NEMA 4/12 plastic front panel**
- **Outside connectors**
- **Drive bay**
- **30 CFM cooling fan**
- **Power switch**
- **Power inlet & fuse**

Features

AMB-2021 (12.1"LCD + ACS-2301 Control Box)

- 12.1" SVGA color TFT LCD display
- Heavy-duty steel chassis and NEMA 4/12 compliant plastic front panel
- All-in-one SBC, Intel Celeron 366MHz CPU, 32MB SDRAM, Ethernet, VGA.
- Four 16C550 RS-232C port, one RS-232C port can be set as RS-422/485 also
- Disk Driver Space for CD-ROM, FDD and HDD
- DiskOnChip flash disk socket
- Print Port
- One expansion slot
- Touch Screen (optional)

AMB-2051 (15"LCD + ACS-2301 Control Box)

- 15" XGA color TFT LCD display
- Heavy-duty steel chassis and NEMA 4/12 compliant plastic front panel
- All-in-one SBC, Intel Celeron 366MHz CPU, 32MB SDRAM, Ethernet, VGA.
- Four 16C550 RS-232C port, one RS-232C port can be set as RS-422/485 also
- Disk Driver Space for CD-ROM, FDD and HDD
- DiskOnChip flash disk socket
- Print Port
- One expansion slot
- Touch Screen (optional)

Specifications

AMB-2021 (12.1"LCD + ACS2301 Control Box)

- **Construction:** Heavy-duty steel chassis & NEMA 4/12 plastic front panel.
- **CPU:** Intel Celeron 366MHz
- **Memory:** 32MB SDRAM
- **Display:** 12.1" SVGA (800 x 600) TFT color LCD
- **LCD/CRT controller:**
C&T 69000 VGA controller with 2MB embedded SDRAM. CRT & LCD panel support
- **Network (LAN):**
Realtek RTL8139B 10/100 Base-T Ethernet controller
- **I/O ports:**
Win bond W83977
COM1/3: RS-232
COM2: RS-232 or RS-422/485(jumper select)
1 parallel port (support ECP/EPP)
1 keyboard port
1 PS/2 mouse interface
- **Disk Driver Housing:**
3.5"HDD & Slim-size CD-ROM or 2.5"HDD, Slim-size CD-ROM and slim-size FDD
- **USB connector:** Dual USB ports onboard
- **Mounting:** Panel mount or Wall mount (ACS-2301 Control Box only, optional)
- **Power supply:** Universal 70W switching power supply

AMB-2051 (15"LCD + ACS2301 Control Box)

- **Construction:** Heavy-duty steel chassis & NEMA 4/12 plastic front panel.
- **CPU:** Intel Celeron 366MHz
- **Memory:** 32MB SDRAM
- **Display:** 15" XGA (1024 x 768) TFT color LCD
- **LCD/CRT controller:**
C&T 69000 VGA controller with 2MB embedded SDRAM. CRT & LCD panel support
- **Network (LAN):**
Realtek RTL8139B 10/100 Base-T Ethernet controller
- **I/O ports:**
Win bond W83977
- **COM 1,3:** RS-232
- **COM 2:**
RS-232 or RS-422/485(jumper select)
1 parallel port (support ECP/EPP)
1 keyboard port
1 PS/2 mouse interface
- **Disk Driver Housing:**
3.5"HDD & Slim-size CD-ROM or 2.5"HDD, Slim-size CD-ROM and slim-size FDD
- **USB connector:** Dual USB ports onboard
- **Mounting:** Panel mount or Wall mount (ACS-2303 Control Box only, optional)
- **Power supply:** Universal 70W switching power supply.

Power Supply Selection Table

Mode	Input voltage	Max. Output Current		
		+5V	+12V	-12V
Universal/70W	85-265VAC	12A	2.5A	0.3A
24VDC/70W	10-30VDC	12A	2.5A	0.3A

1.3 Touchscreen (Optional)

- **Type:** 8-wire, analog resistive
- **Resolution:** Continuous
- **Light transmission:** 72% (surface 4H, meets ASTM-D-3363-92A standard.)
- **Operating pressure:** <50 grams for finger, <25 grams for stylus pen. Contact bounce < 10ms
- **Controller:** RS-232 interface
- **Power consumption:** +5V @200mA
- **OS support:** MS DOS, Windows 3.1, Windows 95, Windows 98, Windows NT.

1.4 Order Information

AMB-2021HT:
12.1" Modular system Industrial Panel PC

AMB-2021HTT:
AMB-2021HT with touchscreen

AMB-2051HT:
15" Modular system Industrial Panel PC

AMB-2051HTT:
AMB-2051HT with touchscreen

1.5 LCD Specifications

Model	AMB-2051	AMB-2021
Display type	TFT color LCD	TFT color LCD
Size (diagonal)	15"	12.1"
Number of Pixels	1024(W) x 768(H)	800(W) x 600(H)
Dot size (mm x mm)	0.313(W) x 0.329(H)	0.3075(W) x 0.3075(H)
Contrast ratio	300	250
View angle (Horizontal)	160°	120°
View angle (Vertical)	160°	100°
Luminance (cd/m ²)	250	250
LCD model	Fujitsu FLC3XGC6V-04	Toshiba LTM12C289
Operating Temperature	0 ~ 50 °C	0 ~ 50 °C
Backlight Life-time (Hrs)	25,000	25,000

1.6 Dimensions

AMB-2021HT

(mm)

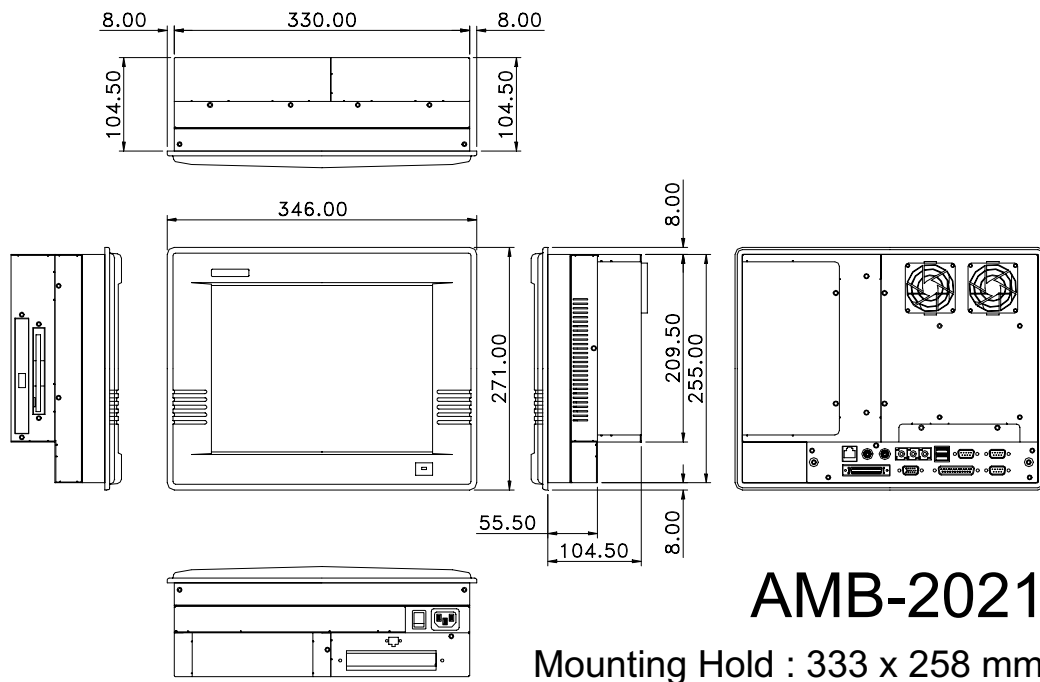

Cutout (suggestion)

The AMB-2023 series will stand on a shelf or a table or you can mount it into a panel. Cutout panel dimensions are the following:

(mm)

H x V : 333mm x 258mm

AMB-2051HT

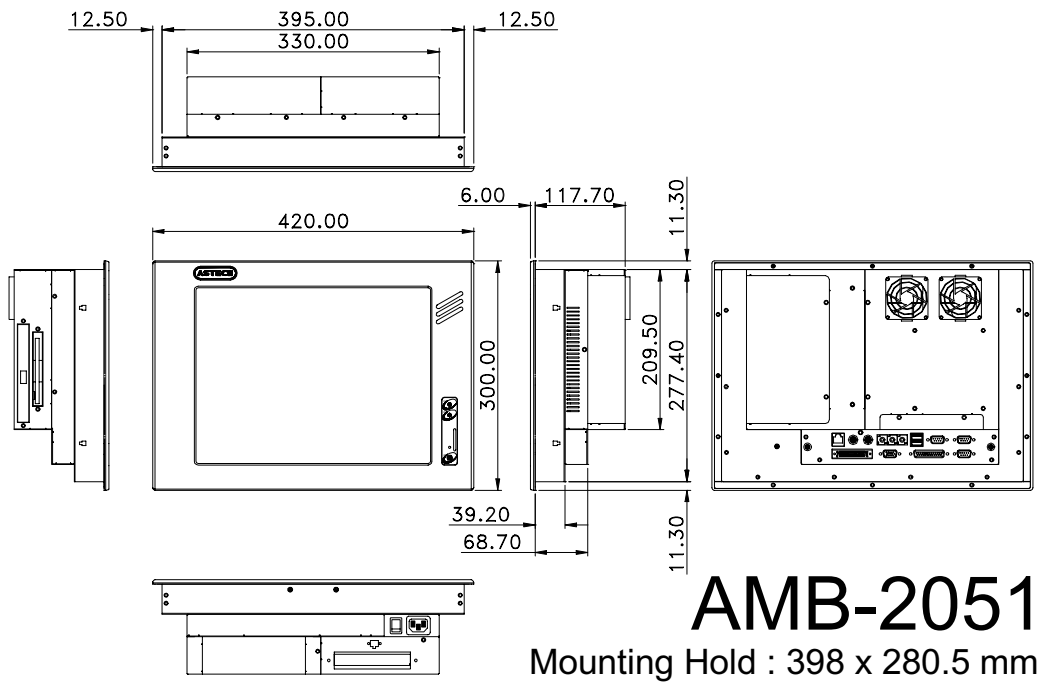
**Cutout (suggestion)**

The AMB-2023 series will stand on a shelf or a table or you can mount it into a panel. Cutout panel dimensions are the following:

(mm)

H x V : 398mm x 280.5mm

1.7 Panel Mounting

This display panels can be placed on a shelf or table, or mounted onto a control panel. To mount them onto a control panel you need a kind of mounting kits, which you will find in the accessory box. Take the mounting steps described here below:

1. Set the display panel within the aperture in your control panel
2. Slide the mounting kits into the slots on the chassis cover
3. Tighten the bolt in the kits until the display panel is firmly secured to the control

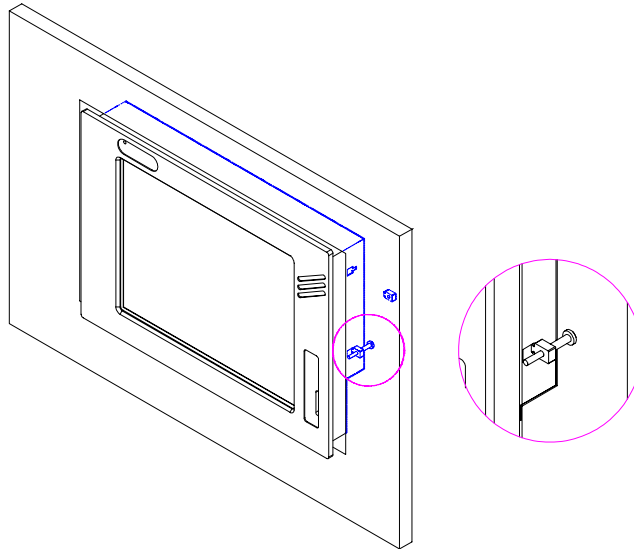

PANEL MOUNTING

1.8 Packing List

Then you should also check if the package contains the following items. You should contact your dealer immediately if any of these items are missing or damaged

- One series industrial MMI panel PC with flat panel display
- Disk for AMB-2021/2051 series user's manual
- Utility & Driver Disks: 5Pcs
 - VGA (C&T69000) Driver for Windows 95/ 98/ NT4.0
 - LAN (RTL8139B) Driver for Windows 95/ 98/ NT4.0
 - Sound (ES1938S) Driver for Windows 95/ 98/ NT4.0
- Accessory
 - Plane for extension solution
 - Power cable for HDD & FDD
 - Screws bag
 - SCSI Cable (1M)
 - Power cord (1.8 M)
 - Assembly mounting parts

If any of their items are missing or damaged, contact your distributor or sales representative immediately.

2

EI7BM SBC

Introduction

This manual is designed to give you information on the EI7BM embedded board. It is divided into the following sections:

2.1 Checklist	14
2.2 Description	14
2.3 Features	14
2.4 Specifications	15
2.5 Board Dimensions	16

2.1 Checklist

Please check that your package is complete and contains the items below. If you discover damaged or missing items, please contact your dealer.

- The EI7BM Embedded Little Board
- This user's manual
- 2 diskettes containing Realtek RTL8139B LAN drivers
- 2 diskettes containing CHIPS 69000 VGA drivers
- 1 diskette containing ESS Solo-1 PCI audio drivers

2.2 Description

EI7BM is a high-performance Embedded Board based on the Intel 440BX AGPset and is designed with a Socket 370 processor connector supporting 66MHz and 100MHz front side bus. With one memory bank on board, up to 256MB of SDRAM can be supported.

The EI7BM Embedded Board comes with CHIPS 69000, a highly integrated graphics/flat panel controller. By integrating 2MByte of SDRAM, graphics, flat panel, and CRT control logic on the same die, 69000 delivers superb 2D video performance, consumes minimal power and at the same time reduces the PCB real estate for the graphics subsystem.

The on board Realtek RTL8139B single-chip Fast Ethernet controller provides 32-bit performance, PCI bus master capability, and full compliance with IEEE 802.3u 100Base-T specifications and IEEE 802.3x Full Duplex Flow Control. It also supports Advanced Configuration Power management Interface (ACPI) to achieve the most efficient power management.

The on board Solo-1™ (ES1938S) PCI audio chip implements a single-chip PCI audio solution, providing high-quality audio processing while maintaining full legacy DOS game compatibility. The Solo-1 integrates ESS' field-proven hardware design for DOS game and compatibility with hardware FM synthesis (ESFM).

2.3 Features

- Socket 370 processor connector
- Intel 440BX AGPset
- Intel Celeron 300MHz~600MHz CPU support
- Up to 256MB of SDRAM memory
- CHIPS 69000 VGA chipset
- ESS Solo-1 (ES1938S) PCI audio chip
- Realtek RTL8139B 10/100Mbps Ethernet controller
- Four COM ports, EISA expansion slot
- Hardware monitoring, DiskOnChip support, Watchdog timer

2.4 Specifications

- **Processor Socket:** Socket 370
- **Processors Supported:** Intel Celeron 300MHz~800MHz
- **Chipset:** Intel 440BX AGPset
- **Memory:** 32MB~256MB SDRAM
- **BIOS:** Award BIOS, PnP support
- FLASH EEPROM (128KB) for BIOS update
- ISA Plug and Play (PnP) extension
- Power management
- **Multi I/O:** Winbond 83977TF and 83877TF
- **Parallel Port:** One high-speed parallel port, SPP/EPP/ECP mode
- **Serial Port:** three RS-232 with 16 byte FIFO and one RS-232/422/485 with 16 byte FIFO COM ports
- **Enhanced IDE:** Two Bus Mastering EIDE mode, up to 4 devices; two EIDE interfaces for up to 4 devices; supports PIO Mode 3/4 or Ultra DMA/33 IDE hard disks, ATAPI CD-ROM, and LS-120.
- **FDD Interface:** Two floppy drives; supports 360KB, 720KB, 1.2MB, 1.44MB and 2.88MB formats
- **VGA Display:**
 - CHIPS 69000 VGA accelerator for SVGA for CRT & Panel
 - 32-bit PCI local bus
 - VGA BIOS with 128KB flash ROM and system BIOS
 - 15-pin VGA connector
 - 1024x768(High Color) resolution on board
 - 2MB integrated memory
 - 83 MHz SDRAM operation
 - Low Power Consumption
 - Panel-off power saving mode
 - PC97 and PC98 Compatible
 - 256-ball BGA package
- **Audio Support**
 - ESS Solo-1 (ESS1938) PCI audio chip
 - Provides high-quality audio processing
 - Maintains full legacy DOS game compatibility
 - Proven hardware design for DOS game and compatibility with hardware FM synthesis (ESFM) and three methods for legacy audio control interface.

- **SSD Interface:** One 32-pin DIP socket supports M-Systems DiskOnChip 2000 series up to 144MB
- **USB Interface:** Two USB connectors, compliant with USB Specification Rev. 1.0
- **Watchdog Timer:** 16 levels
- **Hardware Monitoring:** Winbond 83781D
- Monitoring CPU/system temperature and voltages to prevent system crashes by warning user before they happen.
- **Keyboard/Mouse Connectors:** PS/2 type connectors
- **Environmental and Mechanical:**
 - **Temperature:** 0°C to 60°C
 - **Humidity:** 5% to 95%
 - **Dimensions:** 230mm x 210mm

2.5 Board Dimensions

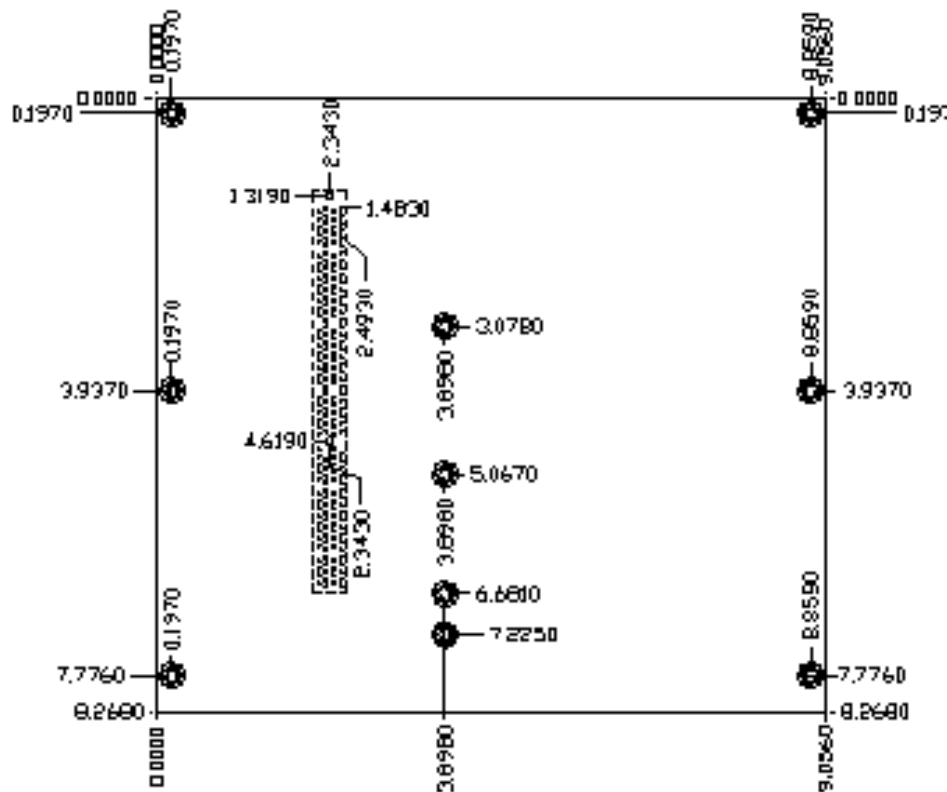

3 Hardware Installations

This chapter provides information on how to use the jumpers and connectors on the EI7BM in order to set up a workable system. The topics covered are:

<u>3.1 CPU Installation</u>	18
<u>3.2 Memory Installation</u>	19
<u>3.3 Jumpers on the EI7BM</u>	20
<u>3.4 Connectors on the EI7BM</u>	26

3.1 CPU Installation

The EI7BM Embedded Board supports a Socket 370 processor socket for Intel Celeron processors.

To install the processor on the socket, raise the lock lever to a vertical position. Insert the processor by making sure the notch on the corner of the processor corresponds with the notch on the inside of the socket. Once the CPU is inserted, lock the CPU in place by returning the lever to the lock position.

After you have installed the processor into the socket, check if the jumpers for the CPU frequency is correct. Refer to the relevant section in this manual.

NOTE *Ensure that the CPU heat sink and the CPU top surface are in total contact to avoid CPU overheating problem that would cause your system to hang or be unstable.*

3.2 Memory Installation

The EI7BM Embedded Board supports one 168-pin DIMM socket for a maximum total memory of 256MB. The SDRAM sizes can be 32MB, 64MB, 128MB and 256MB.

Installing and Removing DIMMs

To install the DIMM module, locate the memory slot on the EI7BM and perform the following steps:

1. Hold the DIMM so that the two keys of the DIMM align with those on the memory slot.
2. Gently push the DIMM in an upright position until the clips of the slot close to hold the DIMM in place when the DIMM touches the bottom of the slot.
3. To remove the DIMM, press the clips with both hands.

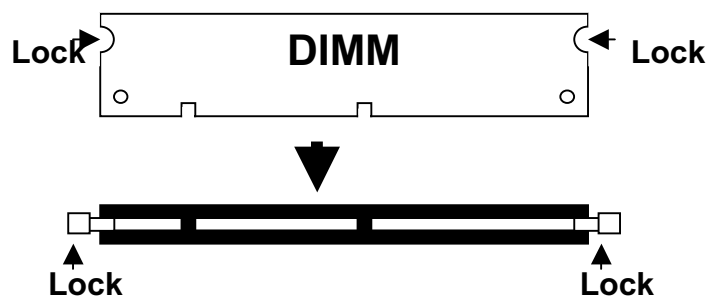

Top View of DIMM Socket

3.3 Jumpers on the EI7BM

The jumpers on the EI7BM allow you to configure your embedded board according to the needs of your applications. If you have doubts about the best jumper configuration for your needs, contact your dealer or sales representative. The following table lists the connectors on EI7BM and their respective functions.

Jumper Locations on the EI7BM.....	21
DSW1 (3): CPU Bus Speed Selector	22
DSW1 (5-8): CPU Frequency Selector	22
JP5: DiskOnChip BIOS Expansion Address Select	23
JP6: Clear CMOS Content.....	23
JP7: External Battery Connector	23
JP8: ATX/AT Power Function Select.....	24
JP9: LCD Power Setting.....	24
J11: RS232/422/485 (COM2) Selection	25

Remarks: The following conventions are used in this section:

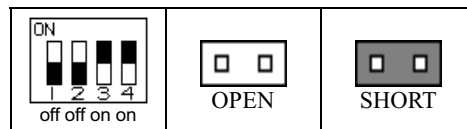

Jumper Locations on the EI7BM

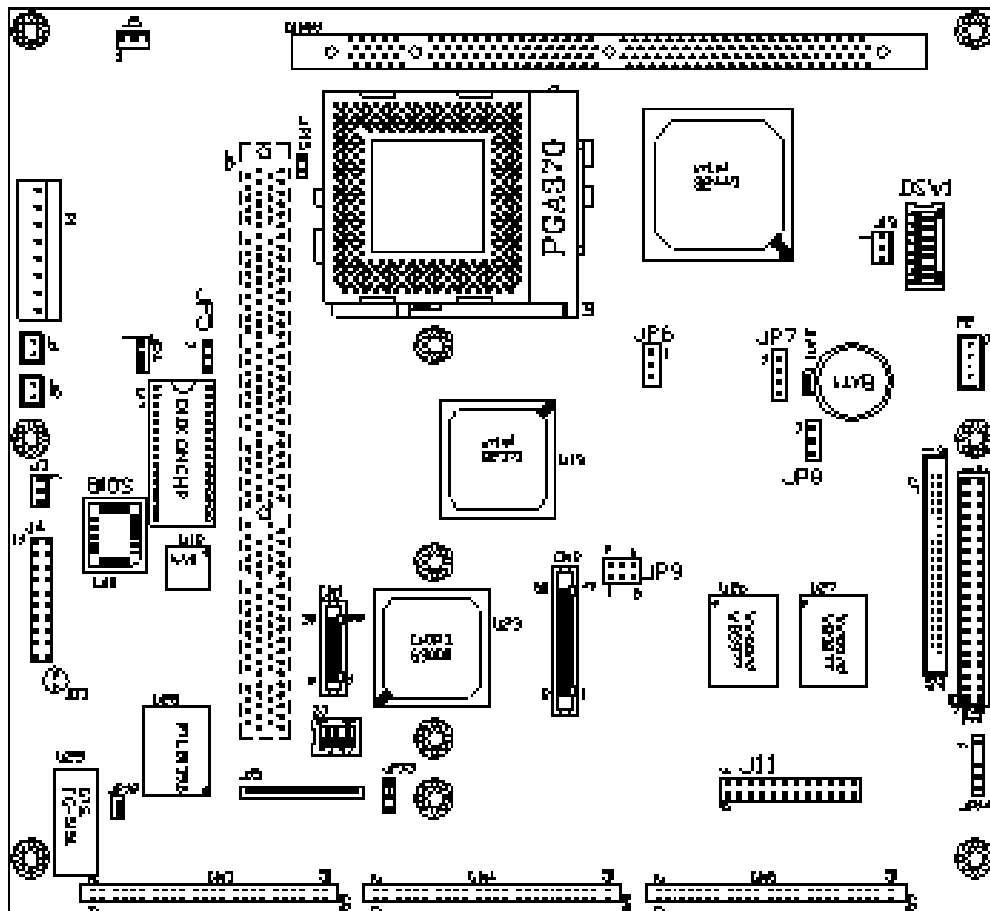

Switch and Jumpers:

DSW1 (3): CPU Bus Speed Selector

DSW1 (5-8): CPU Frequency Selector

JP5: DiskOnChip BIOS Expansion Address Select

JP6: Clear CMOS Content

JP7: External Battery Connector

JP8: ATX/AT Power Function Select

JP9: LCD Power Setting

J11: RS232/422/485 (COM2) Selection

DSW1 (3): CPU Bus Speed Selector

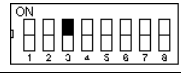

Bus Speed	DSW1 (3)	Switch Setting
100MHz		off
66MHz		on

DSW1 (5-8): CPU Frequency Selector

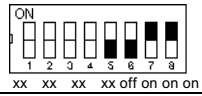
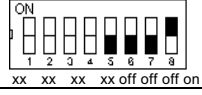
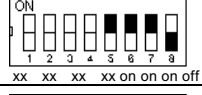
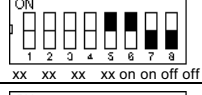
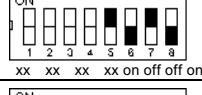
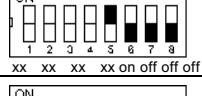
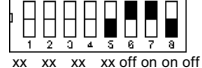

The table below shows the correct setting to match the CPU frequency.

Frequency Multiplier	CPU Frequency (66MHz)	CPU Frequency (100MHz)	DSW1(5-8)
4.5X	300MHz	450MHz	
5X	333MHz	500MHz	
5.5X	366MHz	550MHz	
6X	400MHz	600MHz	
6.5X	433MHz	650MHz	
7X	466MHz	700MHz	
7.5X	500MHz	750MHz	
8X	533MHz	800MHz	

JP5: DiskOnChip BIOS Expansion Address Select

JP5	Address
	D0000-D7FFF
	D8000-DFFFF (default)

JP6: Clear CMOS Content

JP6	Setting	Function
	Pin 2-3 Short/Closed	Clear CMOS Content
	Pin 1-2 Short/Closed	Normal Operation

Follow the steps below to clear CMOS data.

1. Disconnect the AC power cord.
2. Short JP6 (1-2) and wait for 3 seconds.
3. Short JP6 (2-3) and replace the AC power cord.
4. Turn on the system.

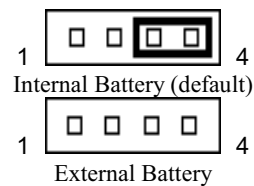

JP7: External Battery Connector

This 4-pin connector allows the user to connect an external battery to maintain the information stored in the CMOS RAM in case the built-in battery malfunctions.



Pin #	Signal Name
1	Vcc
2	N.C.
3	Battery GND
4	Ground

JP8: ATX/AT Power Function Select

JP8	Setting	Function
	Pin 1-2 Short/Closed	ATX Power
	Pin 2-3 Short/Closed	AT Power

JP9: LCD Power Setting

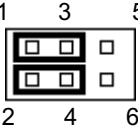
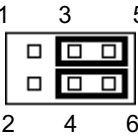
JP9	Setting	Function
	Pin 1-3, 2-4 Short/Closed	3.3V
	Pin 3-5, 4-6 Short/Closed	5V

J11: RS232/422/485 (COM2) Selection

COM1 is fixed for RS-232 use only.

COM2 is selectable for RS232, RS-422 and RS-485.

The following table describes the jumper settings of this connector.

COM2 Function	RS-232	RS-422	RS-485
Jumper Setting (pin closed)	all jumpers open	1-2 3-4 5-6 7-8 11-12 15-16 17-18 19-20 23-24	1-2 3-4 5-6 7-8 9-10 11-12 13-14 15-16 17-18 19-20 21-22
Jumper Illustration			

3.4 Connectors on the EI7BM

The EI7BM Embedded Board consists of a main board and an extension board (EI710) with connectors that allows interface with external peripherals. Listed below are the connectors on the EI7BM Embedded Board.

Connector Locations on the EI7BM	27
P1: Power Connector	29
J3, J5, J13: Fan Power Connectors	29
J2: Power Button Connector	29
J4: System Function Connectors	30
J6: EISA Slot	31
J7, J8: IDE1 Connectors	32
JP14: IrDA Connector	33
J15: Floppy Drive Connector	33
J3: IDE Connector (on EI710)	34
J4: FDD Connector (on EI710)	35
J5: RJ-45 Connector (on EI710)	35
J6: PS/2 Keyboard Connector (on EI710)	36
J7: PS/2 Mouse Connector (on EI710)	36
J8, J9, J10: Audio Connectors (on EI710)	36
J11: USB Connector (on EI710)	37
J12, J13, J17: COM1/2/3 Serial Ports (on EI710)	37
J14: Reserved Connector (on EI710)	37
J15: VGA Port Connector (on EI710)	38
J16: Parallel Port Connector (on EI710)	39

Connector Locations on the EI7BM

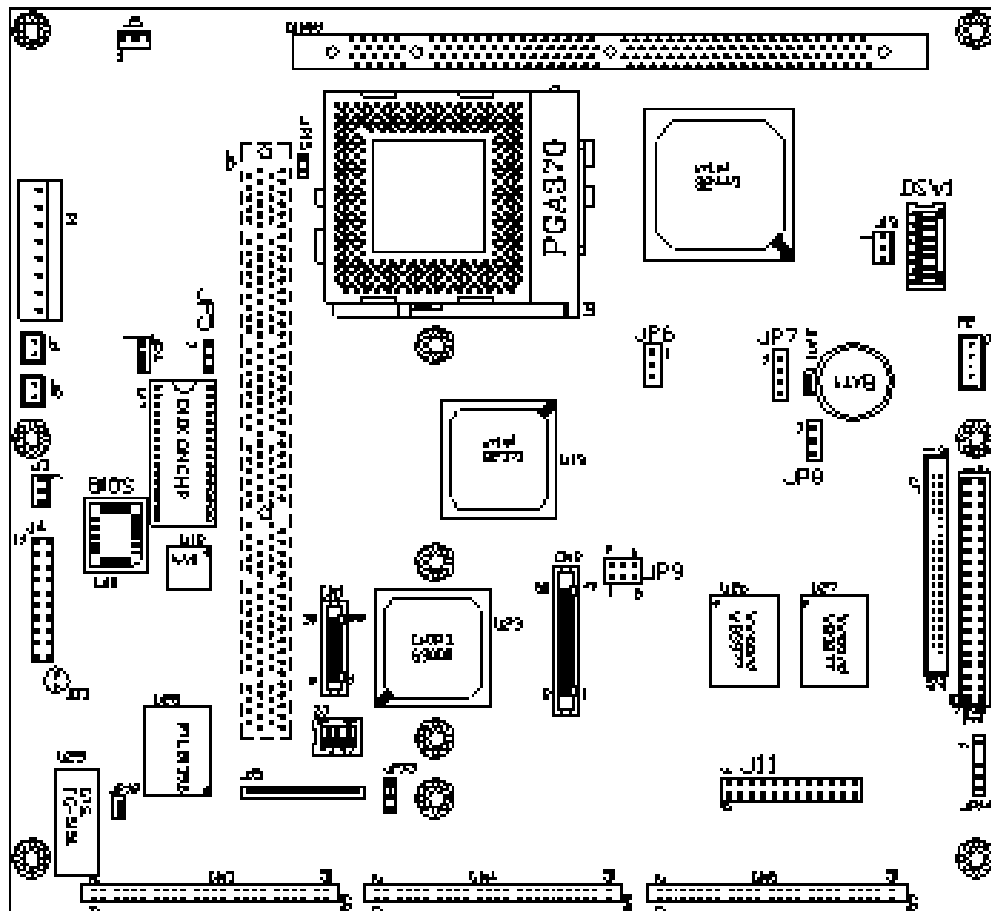

Connectors:

- P1: Power Connector
- J3, J5, J13: Fan Power Connectors
- J2: Power Button Connector
- J4: System Function Connectors
- J6: EISA Slot
- J7, J8: IDE1 Connectors
- JP14: IrDA Connector
- J15: Floppy Drive Connector

Connector Locations on the EI7BM (continued from last page)

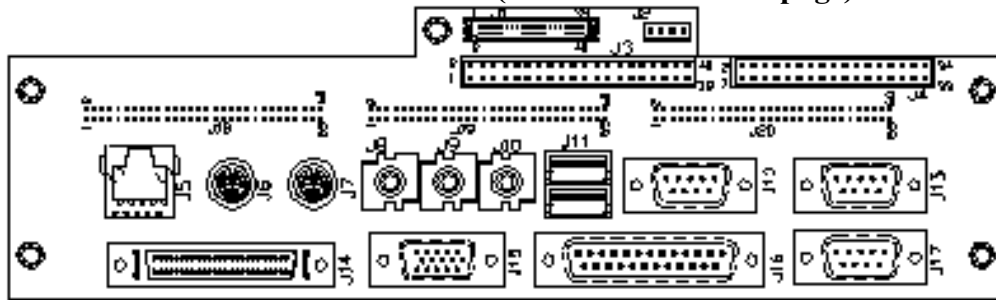

Connectors

J3: IDE Connector (on EI710)

J4: FDD Connector (on EI710)

J5: RJ-45 Connector (on EI710)

J6: PS/2 Keyboard Connector (on EI710)

J7: PS/2 Mouse Connector (on EI710)

J8, J9, J10: Audio Connectors (on EI710)

J11: USB Connector (on EI710)

J12, J13, J17: COM1/2/3 Serial Ports (on EI710)

J14: Reserved Connector (on EI710)

J15: VGA Port Connector (on EI710)

J16: Parallel Port Connector (on EI710)

P1: Power Connector

P1 power connector has the following pin assignments.

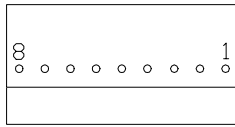

Pin #	Signal Name
1	+5V
2	+5V
3	+5V
4	Ground
5	Ground
6	Ground
7	+12V
8	-12V

J3, J5, J13: Fan Power Connectors

J3, J5 and J13 are 3-pin header connectors for the system fan, CPU fan and auxiliary fan respectively. Plug in the fan cable to the connector. Pin-2 corresponds to the RED power lead.

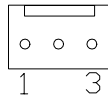

Pin #	Signal Name
1	No Connect
2	+12V
3	Ground

J3: System Fan Conn.
J5: CPU Fan Conn.
J13: Auxiliary Fan Conn.

J2: Power Button Connector

J2 is a 2-pin header for the power button. Connect the cable for the power button to the connector. There is no need for any orientation.

J4: System Function Connectors

The system function connectors interface to indicators in the system on computer activities and switches to change the computer status. J4 is a 20-pin header that provides interfaces for the following functions.

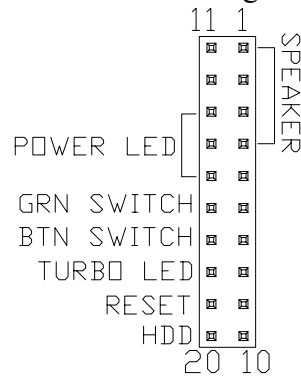

Speaker: Pins 1 - 4

This connector provides an interface to a speaker for audio tone generation. An 8-ohm speaker is recommended.

Pin #	Signal Name
1	Speaker out
2	No connect
3	Ground
4	+5V

Power LED: Pins 11 - 15

The power LED indicates the status of the main power switch. The keylock switch, when closed, will disable the keyboard function.

Pin #	Signal Name
11	Power LED
12	No connect
13	Ground
14	Keylock
15	Ground

Ground Switch: Pins 6/ 16

This connector supports the "Green Switch" on the control panel, which, when pressed, will force the system into the power-saving mode immediately.

Pin #	Signal Name
6	Sleep
16	Ground

ATX Power ON Switch: Pins 7 and 17

This 2-pin connector is an “ATX Power Supply On/Off Switch” on the system that connects to the power switch on the case. When pressed, the power switch will force the system to power on. When pressed again, it will force the system to power off.

Turbo LED: Pins 8 and 18

There is no turbo/deturbo function on the CPU card. The Turbo LED on the control panel will always be On when attached to this connector.

Pin #	Signal Name
8	5V
18	Ground

Reset Switch: Pins 9 and 19

The reset switch allows the user to reset the system without turning the main power switch off and then on again. Orientation is not required when making a connection to this header.

Hard Disk Drive LED: Pins 10 and 20

This connector connects to the hard drive activity LED on control panel. This LED will flash when the HDD is being accessed.

Pin #	Signal Name
10	Ground
20	5V

J6: EISA Slot

J6 is the EISA Slot that supports the optional BE11PI riser. The riser integrates one PCI slot and one ISA expansion slot.

J7, J8: IDE1 Connectors

Signal Name	Pin #	Pin #	Signal Name
Reset IDE	1	2	Ground
Host data 7	3	4	Host data 8
Host data 6	5	6	Host data 9
Host data 5	7	8	Host data 10
Host data 4	9	10	Host data 11
Host data 3	11	12	Host data 12
Host data 2	13	14	Host data 13
Host data 1	15	16	Host data 14
Host data 0	17	18	Host data 15
Ground	19	20	Key
DRQ0	21	22	Ground
Host IOW	23	24	Ground
Host IOR	25	26	Ground
IOCHRDY	27	28	Host ALE
DACK1	29	30	Ground
MIRQ0	31	32	No connect
Address 1	33	34	No connect
Address 0	35	36	Address 2
Chip select 0	37	38	Chip select 1
Activity	39	40	Ground
Vcc	41	42	Vcc
Ground	43	44	N.C.

Signal Name	Pin #	Pin #	Signal Name
Reset IDE	1	2	Ground
Host data 7	3	4	Host data 8
Host data 6	5	6	Host data 9
Host data 5	7	8	Host data 10
Host data 4	9	10	Host data 11
Host data 3	11	12	Host data 12
Host data 2	13	14	Host data 13
Host data 1	15	16	Host data 14
Host data 0	17	18	Host data 15
Ground	19	20	Key
DRQ0	21	22	Ground
Host IOW	23	24	Ground
Host IOR	25	26	Ground
IOCHRDY	27	28	Host ALE
DACK0	29	30	Ground
IRQ14	31	32	No connect
Address 1	33	34	No connect
Address 0	35	36	Address 2
Chip select 0	37	38	Chip select 1
Activity	39	40	Ground

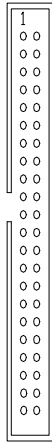

J7
IDE1
44-pin

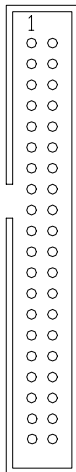

J8
IDE1
40-pin

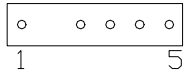
JP14: IrDA Connector

Pin #	Signal Name
1	Vcc
2	No Connect
3	IR RX
4	Ground
5	IRTX

J15: Floppy Drive Connector

J15 is the 26-pin slim floppy drive connector on EI7BM. The following table shows its pin-out assignments.



J4
26-pin

Signal Name	Pin #	Pin #	Signal Name
Vcc	1	2	Index
Vcc	3	4	Drive select 0
Vcc	5	6	Diskette change
N.C.	7	8	N.C.
N.C.	9	10	Motor enable 0
N.C.	11	12	Direction
RM/LC	13	14	Step
Ground	15	16	Write data
Ground	17	18	Write gate
Ground	19	20	Track 00
Ground	21	22	Write protect
Ground	23	24	Read data
Ground	25	26	Side 1 select

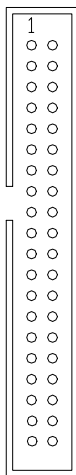
J3: IDE Connector (on EI710)

J3

Signal Name	Pin #	Pin #	Signal Name
Reset IDE	1	2	Ground
Host data 7	3	4	Host data 8
Host data 6	5	6	Host data 9
Host data 5	7	8	Host data 10
Host data 4	9	10	Host data 11
Host data 3	11	12	Host data 12
Host data 2	13	14	Host data 13
Host data 1	15	16	Host data 14
Host data 0	17	18	Host data 15
Ground	19	20	Key
DRQ0	21	22	Ground
Host IOW	23	24	Ground
Host IOR	25	26	Ground
IOCHRDY	27	28	Host ALE
DACK0	29	30	Ground
IRQ14	31	32	No connect
Address 1	33	34	No connect
Address 0	35	36	Address 2
Chip select 0	37	38	Chip select 1
Activity	39	40	Ground

J4: FDD Connector (on EI710)

J4 is the 34-pin floppy drive connector. The following table shows its pin-out assignments.

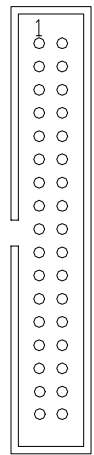

J4
34-pin

Signal Name	Pin #	Pin #	Signal Name
Ground	1	2	RM/LC
Ground	3	4	No connect
Ground	5	6	No connect
Ground	7	8	Index
Ground	9	10	Motor enable 0
Ground	11	12	Drive select 1
Ground	13	14	Drive select 0
Ground	15	16	Motor enable 1
Ground	17	18	Direction
Ground	19	20	Step
Ground	21	22	Write data
Ground	23	24	Write gate
Ground	25	26	Track 00
Ground	27	28	Write protect
Ground	29	30	Read data
Ground	31	32	Side 1 select
Ground	33	34	Diskette change

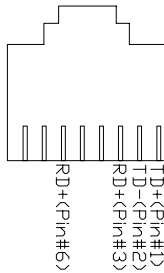
J5: RJ-45 Connector (on EI710)

The RJ-45, short for Registered Jack-45, is an eight wire connector used to connect the system onto a local-area network (LAN). The Ethernet function on the EI7BM supports 10/100Mbps data transfer rates.

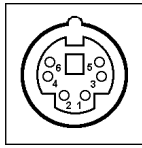
J6: PS/2 Keyboard Connector (on EI710)

Pin #	Signal Name
1	Keyboard data
2	N.C.
3	GND
4	5V
5	Keyboard clock
6	N.C.

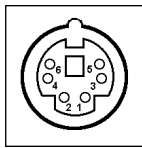
J7: PS/2 Mouse Connector (on EI710)

Pin #	Signal Name
1	Mouse data
2	N.C.
3	GND
4	5V
5	Mouse clock
6	N.C.

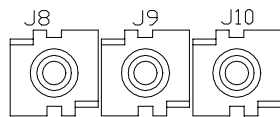
J8, J9, J10: Audio Connectors (on EI710)

LINE LINE MIC.
OUT IN

J11: USB Connector (on EI710)

J11 is the standard USB external connector consisting of two ports. USB support allows connections of up to 64 plug and play external peripherals per channel. The following table shows the pin outs of these ports.

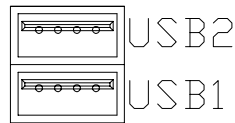

Pin #	Signal Name
1	Vcc
2	USB-
3	USB+
4	Ground

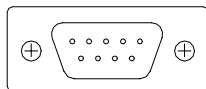
J12, J13, J17: COM1/2/3 Serial Ports (on EI710)

J12, J13 and J17 DB-9 connectors are the COM1, COM2, and COM3 serial ports of EI7BM. The following table shows the pin-out assignments of these connectors.

Signal Name	Pin #	Pin #	Signal Name
DCD, Data carrier detect	1	6	DSR, Data set ready
RXD, Receive data	2	7	RTS, Request to send
TXD, Transmit data	3	8	CTS, Clear to send
DTR, Data terminal ready	4	9	RI, Ring indicator
GND, ground	5	10	Not Used

J14: Reserved Connector (on EI710)

J14 is the connector reserved for additional features.

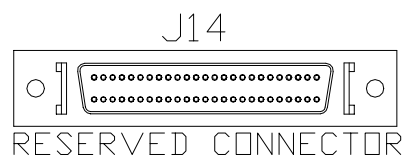

J15: VGA Port Connector (on EI710)

J15 is a DB-15 VGA connector. The following table shows the pin-out assignments of this connector.

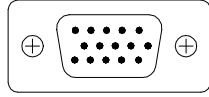

Signal Name	Pin #	Pin #	Signal Name
Red	1	2	Green
Blue	3	4	N.C.
GND	5	6	GND
GND	7	8	GND
N.C.	9	10	GND
N.C.	11	12	N.C.
HSYNC	13	14	VSYNC
NC	15		

J16: Parallel Port Connector (on EI710)

J16 parallel port connector is a DB-25 external connector. The following table describes the pin-out assignments of this connector.

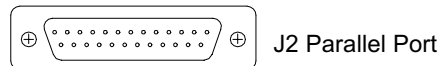

Signal Name	Pin #	Pin #	Signal Name
Line printer strobe	1	14	AutoFeed
PD0, parallel data 0	2	15	Error
PD1, parallel data 1	3	16	Initialize
PD2, parallel data 2	4	17	Select
PD3, parallel data 3	5	18	Ground
PD4, parallel data 4	6	19	Ground
PD5, parallel data 5	7	20	Ground
PD6, parallel data 6	8	21	Ground
PD7, parallel data 7	9	22	Ground
ACK, acknowledge	10	23	Ground
Busy	11	24	Ground
Paper empty	12	25	Ground
Select	13	N/A	N/A