

**PEAK 632A**  
**Single Board Computer**

**User's Manual**

*All brand names are registered trademarks of their respective owners.*

Copyright 2000

All rights reserved

Edition 1.0 July, 2000

The information in this document is subject to change without prior notice in order to improve reliability, design and function. The information in this document does not represent commitment on the part of the manufacturer.

In no event will the manufacturer be liable for direct, indirect, special, incidental, or consequential damages arising out of the use of the PEAK 632A, nor for any infringements upon the rights of third parties which may result from such use.

This document contains proprietary information protected by copyright. All rights are reserved. No part of this manual may be reproduced by any mechanical, electronic, or other means in any form without prior written permission of the manufacturer.

# Table of Contents

## How to Use This Guide

### Chapter 1 Introduction

1.1 Introduction.....	-1
1.2 Features .....	....1-1
1.3 Specifications .....	.1-2
1.4 Packing List ..	1-6

### Chapter 2 Switches and Connectors

2.1 Switches.....	.....2-1
2.2 Connectors.....	.....2-4

### Chapter 3 System Memory and CPU Installation

3.1 System Memory.....	3-1
3.2 Cache Memory .....	3-3
3.3 Chang CPU.....	3-

### Chapter 4 Award BIOS Setup

4.1 Entering Setup.....	.....4-1
4.2 Control Keys .....	..... 4-2
4.3 Getting Help .....	..... 4-3
4.4 The Main Menu .....	..... 4-4
4.5 Standard CMOS Setup .....	..... 4-7
4.6 BIOS Features Setup. ....	..... -11
4.7 Chipset Features Setup.....	.....4-16
4.8 Power Management Setup.....	.....4-20
4.9 PnP/PCI Configuration.....	.....4-25

4.10 IDE HDD Auto Detection .....	4-31
4.11 Supervisor/User Password Setting.....	4-35
4.12 IDE HDD Auto Detection .....	4-36
4.13 Power-On Boot .....	-41
4.14 BIOS Reference – POST messages	4-42
4.15 BIOS Default Drive Table ....	4-48

## **Chapter 5 VGA Driver Installation Procedures**

5.1 Windows 95/98 Drivers Setup Procedure ...	5-1
5.2 Windows NT Drivers Setup Procedure ..	5-12

## **Chapter 6 LAN Driver Installation Procedures**

6.1 Windows 95/98 Drivers Setup Procedure	6-1
6.2 Windows NT Drivers Setup Procedure .....	6-6

## **Chapter 7 SCSI Driver Installation Procedures**

6.1 Windows 95/98 Drivers Setup Procedure	6-1
6.2 Windows NT Drivers Setup Procedure ...	7-11

## **Appendix A Watchdog Timer**

## **Appendix B Memory Mapping**

# How to use this manual

This manual is written to help you use the PCA-6551VE. It describes how to make various settings on the Pentium<sup>®</sup> CPU board to meet your requirements. A brief summary of the manual follows:

**Chapter 1** “Introduction” gives an overview of the product specifications. It also tells you what is included in the product package.

**Chapter 2** “Jumpers and Connectors” describes the definitions and positions of jumpers and connectors that you may easily configure and set up according to your particular requirements.

**Chapter 3** “System Expansion” describes how to change or expand the CPU board by changing the system memory, cache memory, and/or CPU. These changes will yield more power from the CPU board.

**Chapter 4** “Award BIOS Setup” describes how to use the advanced PCI/Green BIOS to control almost every feature of the PCA-6551VE, including the watchdog timer.

**Chapter 5** “VGA Driver Installation Procedures” gives instructions for installing and operating the software drivers on the utility disk included in your package.

**Chapter 6** “LAN Driver Installation Procedures” provides detailed information on Ethernet configuration, and shows how to change the configuration to match your application requirements.

**Chapter 7** “SCSI Driver Installation Procedures” provides detailed information for installing and operating the software drivers, and shows how to change the configuration to match your application requirements.

**Appendix A** “Watchdog Timer” describes how to set up the watchdog timer (WDT), and gives an example of programming the WDT.

**Appendix B** “Memory Mapping” describes usage of the 1st MB memory.

## Chapter 1

### 1-1 Introduction

The PEAK 632A is a full size Single Board Computer. It applies Single Socket 370 FC-PGA based processor, supporting both 66 MHz (Celeron) and 100 MHz (Pentium III) Front Side Bus. The memory it can accommodate is 1 GB SDRAM up to 100 MHz.

Meanwhile, this card is on-board with the following three significant I/Os which help to spare out more PCI slots for other add-on I/Os, i.e. the C&T 69000/69030 VGA/Panel controller through AGP interface; the Intel 82559 Ethernet and the Adaptec 7890 Ultra 2 SCSI. Components with all of the above branded and powerful. PEAK 632A is obviously a formidable platform ideal for heavy duty and computer telephony application.

The other on-board I/Os includes 2S1P, the high precision RTC with battery, the Watch Dog Timer, DOC, IDE × 2, FDC × 1, USB × 2, and PS/2 Keyboard/Mouse.

### 1-2 Features

- Intel Celeron/Pentium III CPU with 66/100MHz FSB up to 850 MHz
- 1 GB SDRAM (Max.) memory support, DIMM × 4
- Intel 440BX AGP set
- C&T 69000 AGP mode VGA controller with CRT/LCD support
- Intel 82559 10/100 Base Ethernet controller
- Adaptec 7890 U2 SCSI controller
- On board socket for DiskOnChip up to 288MB
- RS232 ×2 with 16C550 UARTs, optional RS422/485 ×1
- Enhanced parallel port, support SPP/EPP/ECP
- IDE × 2, FDC × 1, PS/2 keyboard/mouse
- USB port × 2
- Watchdog Timer
- ISAMAX support up to 20 slots ISA card

### **1-3 Specifications**

- **System Architecture**
  - Full size SBC with PCI/ISA Golden finger
  - Intel Socket 370 Celeron/Pentium III with 66/100MHz FSB
  - PCI V2.1 complied
  - PICMG 1.0 (Rev.2.0) complied
- **CPU Support**
  - Intel Celeron/Pentium III CPU with 128/256K cache on die
  - Brand New Socket 370 FC-PGA CPU running at 66/100MHz FSB up to 850MHz
  - Support streaming SIMD instruction
- **Main Memory**
  - Support SDRAM up to 1GB (Max.)
  - 168 pin DIMM socket ×4
  - ECC support (single bit error correction/Multiple bit errors reporting)
- **BIOS**
  - Award System BIOS
  - Plug & Play support
  - Advanced Power Management support
  - Advanced configuration & Power Interface support
  - 2M bit flash ROM
- **Chip Set**
  - Intel 82440BX AGP set
  - 66/100MHz FSB support
  - PCI V2.1 complied
  - Optimized SDRAM support
- **On Board VGA**
  - C&T 69000 AGP mode VGA controller
  - TFT LCD/DSTN LCD/CRT control

- 2MB SDRAM on die

Maximum Res. Color & Refresh Rate Resolution	Colors	Refresh Rate (Hz)
1280×1024	256	60
1024×768	16bits (High color)	85, 75, 65
800×600	24bits (True color)	85, 75, 65

- Driver support : Windows 95/98, Windows NT4.0
- 15 pin CRT connector ×1, 50 pin LCD panel connector ×1
- **On Board LAN**
  - Intel 82559 Single Ethernet controller
  - 10 Base T/100 Base TX support, full duplex
  - Complied with PCI V2.1, IEEE802.3, IEEE 802.3U
  - Backward compatible with former 82558 Ethernet controller base net modules
  - Driver support: DOS/Windows, Windows 95/98, Windows NT4.0, Netware, SCO Open Server 5.0
  - RJ45 connector ×1
- **On Board SCSI**
  - Adaptec AIC 7890 RISC SCSI controller
  - Brand New Ultra 2 SCSI support
  - 80MB/s (Max.) transfer rate, up to 12 meter cable
  - Backward compatible with Ultra Wide SCSI, SCSI II, etc.
  - Driver support: Windows 95/98, Windows NT4.0, SCO Open Server 5.0
  - 68 pin SCSI connector ×1
- **On Board I/O**
  - Winbond W83977 Super I/O on board
  - SIO ×2, with 2×16C550 UARTs, 9 pin D-type ×1, 10 pin HEADER ×1, optional RS422/485 ×1
  - PIO ×1, Bi-directional, EPP/ECP support, 26 pin ×1
  - Floppy Disk controller: 5.25" 360K/1.2MB, 3.5"

720K/1.2MB/1.44MB/2.88MB support, 34 pin connector ×1

- On chip enhanced IDE ×2, PIO up to mode 4, DMA master up to mode 2, Ultra DMA/33 support, 40 pin ×2, total 4 E.IDE Devices support
- On chip keyboard, mouse controller, PS/2 Keyboard · Mouse, 5 pin header ×1, 6 pin mini DIN × 2, (for Peak632V/Peak632) ; PS/2 Keyboard, 6 pin mini DIN ×1, share with PS/2 mouse by Y cable (for Peak632A/Peak632VL)
- On board USB port ×2 (6 pin header ×1)
- On board buzzer ×1
- On board 2 pin header for reset SW, 4 pin for speaker, 5 pin for keylock
- On board 3 pin header for +5VSTBY, GND, Power ON#
- On board 2 pin header for I<sup>2</sup>C
- On board reserved CAN Bus connector
- **On Board RTC**
  - High precision real time clock/calendar with battery back up
- **On Board Solid State Disk Socket**
  - On board reserved socket for DOC of M-systems : 2MB~144MB, etc
- **System Monitor**
  - Winbond W83782D system monitor controller
  - Six voltage (For +3.3V, +5V, +12V, -12V, Vtt and Vcore )
  - One Fan speed (For CPU)
  - Two temperature
  - Drivers support: Windows 95/98, Windows NT4.0
- **ISAMAX Support**
  - Maximize ISA signals to support ISA cards up to 20
- **Watchdog Timer**
  - 1,2,4 4 seconds time-out intervals
- **Dimensions**
  - 340mm(D) × 122mm(W)
- **Power Requirements**
  - +5V : 20A (Max.)

- +12V: 500mA (Max.)
- -12V: 50mA (Max.)
- **Environments**
  - Operating temperatures : 0°C to 60°C
  - Storage temperatures : -20°C to 80°C
  - Relative humidity : 10% to 90% (Non-condensing)
- **Certification**
  - CE approval
  - FCC Class A
- **Model Available**
  - PEAK 632A--Full-size Socket 370 Celeron/Pentium III AIO CPU Card
  - PEAK 632VL-- Full-size Socket 370 Celeron/Pentium III CPU Card w/VGA/LAN
  - PEAK 632V-- Full-size Socket 370 Celeron/Pentium III CPU Card w/VGA
  - PEAK 632-- Full-size Socket 370 Celeron/Pentium III CPU Card

### 1-4 What you'll have from the package

In addition to this manual, the PEAK 632A series package includes the following items.

Model \ ITEM	Peak 632A	Peak 632VL	Peak 632V	Peak 632
Peak 632A series CPU card	1	1	1	1
IDE cable	1	1	1	1
FDC cable	1	1	1	1
Serial & Printer port cable	1	1	1	1
5 pin to 5 pin keyboard cable	1	1	1	1
Y cable for keyboard & mouse	1	1	×	×
UW SCSI cable	1	×	×	×
C&T 69000 VGA driver disks	1	1	1	×
Intel 82559 Ethernet driver disks	2	2	×	×
Adaptec 7890 driver disks	3	×	×	×
Winbond W83782D driver disks	3	3	3	3

If any of these items is missed or damaged, please contact your vendor for what you want.

# Chapter 2

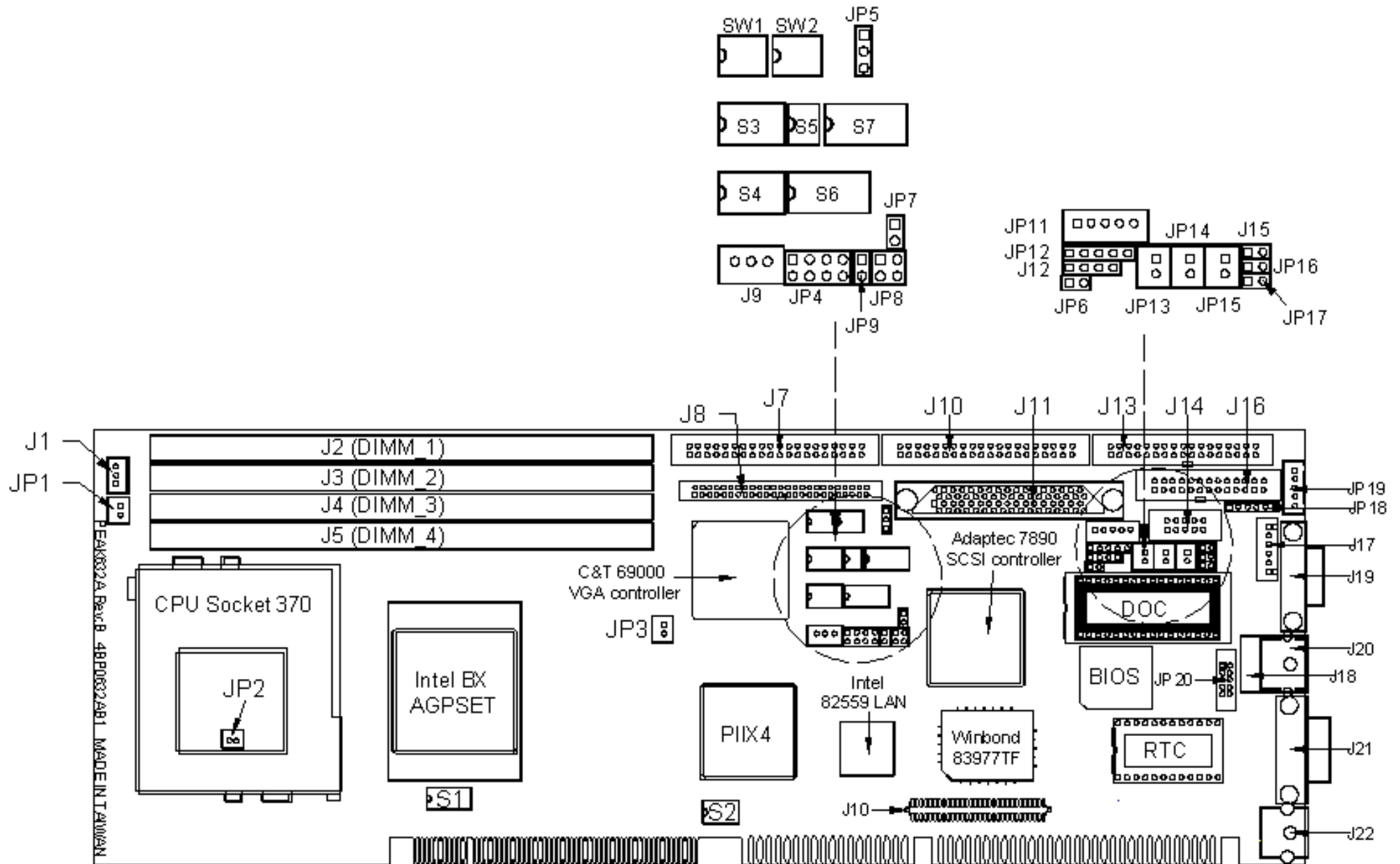

Figure 2-1 Switches and Connectors position

This chapter gives the definitions and shows where to locate the positions of switches and connectors.

## 2-1 Switches

Switches on the CPU board are used to select options for different functions used. The switch-on or off is to accommodate the variations of the following table.

### Switch Setting Table (\*: default setup)

#### AT/ATX FUNCTION SELECT

	*AT Function	ATX Function
JP4	1-2,3-4	5-6,7-8
JP7	N/C	1-2
JP8	1-2	3-4

#### CPU Frequency

	S1.1	S1.2	S1.3	S1.4	S1.5	S1.6	S1.7
*100	OFF	OFF	ON	OFF	OFF	OFF	OFF
66	ON	ON	ON	OFF	OFF	ON	OFF

#### CPU Pipelined

	S1.8
*Enabled	OFF
Disabled	ON

#### DEVICE SELECT

	S2.1	S2.2	S2.3	S2.4	S2.5	S2.6
*VGA Enabled	ON	OFF	X	X	X	X
VGA Disabled	OFF	ON	X	X	X	X
*SCSI Enabled	X	X	ON	OFF	X	X
SCSI Disabled	X	X	OFF	ON	X	X
*LAN Enabled	X	X	X	X	ON	OFF
LAN Disabled	X	X	X	X	OFF	ON

**M-System Disk On Chip**

	<b>S4.1</b>	<b>S4.2</b>	<b>S4.3</b>
Disabled	OFF	X	X
C0000	ON	ON	ON
C8000	ON	ON	OFF
D0000	ON	OFF	ON
*D8000	ON	OFF	OFF

**BIOS Fresh**

	<b>S4.4</b>
Enabled	ON
*Disabled	OFF

**IRQ12 (Mouse Controller) Release**

	<b>S4.6</b>
*Enabled	ON
Disabled	OFF

**RTC Clear**

	<b>S4.5</b>
Enabled	ON
*Disabled	OFF

**COM2 RS232 /RS485/RS422**

	<b>S7.1</b>	<b>S7.2</b>	<b>S7.3</b>	<b>S7.4</b>	<b>S7.5</b>	<b>S7.6</b>	<b>S7.7</b>	<b>S7.8</b>	<b>S3.1</b>	<b>S3.2</b>	<b>S3.3</b>
*RS232	OFF	ON	OFF	ON	OFF	ON	OFF	ON	ON	OFF	OFF
RS485	ON	OFF	ON	OFF	ON	OFF	ON	OFF	OFF	OFF	ON
RS422	ON	OFF	ON	OFF	ON	OFF	ON	OFF	OFF	ON	OFF

	<b>S6.1</b>	<b>S6.2</b>	<b>S6.3</b>	<b>S6.4</b>	<b>S6.5</b>	<b>S6.6</b>	<b>S6.7</b>	<b>S6.8</b>	<b>S3.4</b>	<b>S3.5</b>
*RS232	OFF	ON	OFF	ON	OFF	ON	OFF	ON	OFF	ON
RS485	ON	OFF	ON	OFF	ON	OFF	ON	OFF	OFF	OFF
RS422	ON	OFF	ON	OFF	ON	OFF	ON	OFF	ON	OFF

**PANEL DIRECTOR**

SW2.4	SW2.3	SW2.2	SW2.1	
On	On	On	On	1024x768 Dual Scan STN Color Panel
On	On	On	Off	1280x1024 TFT Color Panel
On	On	Off	On	1024x768 Dual Scan STN Color Panel:
On	On	Off	Off	1024x768 Dual Scan STN Color Panel
On	Off	On	On	640x480 Sharp TFT Color Panel
On	Off	On	Off	640x480 18Bit TFT Color Panel
On	Off	Off	On	1024x760 TFT Color Panel
On	Off	Off	Off	800x600 TFT Color Panel
Off	On	On	On	800x600 TFT Color Panel
Off	On	On	Off	800x600 TFT Color Panel
*Off	On	Off	On	800x600 Dual Scan STN Color Panel
Off	On	Off	Off	800x600 Dual Scan STN Color Panel
Off	Off	On	On	1024x768 TFT Color Panel
Off	Off	On	Off	1280x1024 Dual Scan STN Color Panel
Off	Off	Off	ON	1024x600 Dual Scan STN Color Panel
Off	Off	Off	Off	1024x600 TFT Color Panel

**PANEL DIRECTOR**

	SW1.1	SW1.2	SW1.3	SW1.4
*MPCLK From PCLK	ON	OFF	X	X
MPCLK From M	OFF	ON	X	X
*DE From M	X	X	ON	OFF
DE From LP	X	X	OFF	ON

**FLASH ROM SIZE**

	S5.1	S5.2
1M	ON	OFF
*2M	OFF	ON

## 2-2 Connectors

### Jumper/Connector define

Connector	Function	Remark
J1	CPU Fan Header	
J2, J3, J4, J5	DIMM Socket	
J7	HDD Connector	
J8	Panel Connector	
J9	ATX Power Connector	
J10	HDD Connector	
J11	SCSI Connector	
J12	Speaker Connector	
J13	FDD Connector	
J14	COM2	
J15	Reset Connector	
J16	Parallel Connector	
J17	USB Connector	
J18	LAN, RJ45 Connector	
J19	CRT Connector	
J20	MOUSE Connector	
J21	COM1	
J22	KB/MS Connector	
JP1, JP2, JP3	Temperature Connector	
JP5	Panel Voltage Connector	
JP6	SMBUS Connector	
JP9	ATX Power Button	
JP10	ISA Connector	
JP11	IR Connector	
JP12	Key Lock	
JP13	LAN Link LED	
JP14	LAN Speed LED	
JP15	LAN Active LED	
JP16	HDD LED	
JP17	SCSI LED	
JP19	Keyboard Connector	
JP20	LAN Connector	
U21	M-SYSTEM DOC	

## Pin definitions of connectors

- **J1: CPU Fan Header Connector**

PIN No.	Description
1	GND
2	+12V
3	Sense

- **J7 /J10: HDD Connector**

PIN No.	Description	PIN No.	Description
1	Reset#	2	Ground
3	Data 7	4	Data 8
5	Data 6	6	Data 9
7	Data 5	8	Data 10
9	Data 4	10	Data 11
11	Data 3	12	Data 12
13	Data 2	14	Data 13
15	Data 1	16	Data 14
17	Data 0	18	Data 15
19	Ground	20	N/C
21	DMA REQ	22	Ground
23	IOW#	24	Ground
25	IOR#	26	Ground
27	IOCHRDY	28	Ground
29	DMA ACK	30	Ground
31	Interrupt	32	NC
33	SA1	34	N/C
35	SA0	36	SA2
37	HDC CS1#	38	HDC CS3#
39	HDD Active#	40	Ground

• **J8: Flat Panel Connector**

<b>PIN No.</b>	<b>Description</b>	<b>PIN No.</b>	<b>Description</b>
1	ENABLK	2	+12VSAFE
3	LP	4	DE
5	SHFCLK	6	FLM
7	P0	8	VDD
9	P2	10	P1
11	P4	12	P3
13	P6	14	P5
15	P8	16	P7
17	P10	18	P9
19	P12	20	VDD
21	P14	22	P11
23	GND	24	P13
25	P16	26	P15
27	P18	28	P17
29	P20	30	ENAVEE
31	P22	32	P19
33	GND	34	P21
35	P24	36	P23
37	P26	38	P25
39	M/PCLK	40	GND
41	P28	42	P27
43	P30	44	P29
45	P32	46	P31
47	P34	48	P33
49	GND	50	P35

• **J9: ATX Power Connector**

PIN No.	Description
1	5VSB
2	GND
3	Power On

• **J12: Speaker Connector**

PIN No.	Description
1	Speaker Signal
2	GND
3	GND
4	+5V

• **J13: FDC Connector**

PIN No.	Description	PIN No.	Description
1	Ground	2	Density Select
3	Ground	4	N/C
5	N/C	6	Drate0
7	Ground	8	Index#
9	Ground	10	Motor Enable A#
11	Ground	12	Drive Select B#
13	Ground	14	Drive Select A#
15	Ground	16	Motor Enable B#
17	Ground	18	Direction#
19	Ground	20	Step#
21	Ground	22	Write Data#
23	Ground	24	Write Gate#
25	Ground	26	Track 0#
27	Ground	28	Write Protect#
29	GPI21	30	Read Data#
31	Ground	32	Head Side Select#
33	Ground	34	Disk Change#

- **J14/J21: Serial Port Connector (D-Sub 9 -pin)**

<b>PIN No.</b>	<b>Description</b>
1	Data Carrier Detect (DCD)
2	Receive Data (RXD)
3	Transmit Data (TXD)
4	Data Terminal Ready (DTR)
5	Ground (GND)
6	Data Set Ready (DSR)
7	Request to Send (RTS)
8	Clear to Send (CTS)
9	Ring Indicator (RI)

- **J15: Reset Connector**

<b>PIN No.</b>	<b>Description</b>
1	RESET
2	GND

- **J16: Parallel Port Connector**

<b>PIN No.</b>	<b>Description</b>	<b>PIN No.</b>	<b>Description</b>
1	Strobe#	2	Data 0
3	Data 1	4	Data 2
5	Data 3	6	Data 4
7	Data 5	8	Data 6
9	Data 7	10	Acknowledge
11	Busy	12	Paper Empty
13	Printer Select	14	Auto Form Feed#
15	Error#	16	Initialize
17	Printer Select IN#	18	Ground
19	Ground	20	Ground
21	Ground	22	Ground
23	Ground	24	Ground
25	Ground	26	N/C

• **J17: USB Connector**

PIN No.	Description
1	+5V
2	USBDO-
3	USBDO+
4	USBD1-
5	USBD1+
6	GND

• **J18: LAN (RJ45) connector**

PIN No.	Description
1	TD+
2	TD-
3	RD+
4	TERMPANE
5	TERMPANE
6	RD-
7	TERMPANE
8	TERMPANE
9	NC
10	NC
11	GND
12	GND

• **J19: CRT connector**

PIN No.	Description
1	RED
2	Green
3	Blue
4	NC
5	GND
6	GND
7	GND
8	GND
9	+5
10	GND
11	NC
12	Display Data channel data
13	Horizontal Sync

14	Vertical Sync
15	Display Data Channel CLK

- **J20: Mouse connector**

PIN No.	Description
1	Mouse Data
2	N/C
3	Ground
4	+5V
5	Mouse Clock
6	N/C

- **J22: Key Board/Mouse Connector**

PIN No.	Description
1	KB/DATA
2	MS/DATA
3	GND
4	5V
5	KB/CLK
6	MS/CLK

- **JP1/JP2/JP3: Temperature Connector**

PIN No.	Description
1	Temperature sensor
2	GND

- **JP5: Panel Voltage**

PIN No.	Description
1-2	For VDD 5V Panel
2-3	For VDD 3.3V Panel

- **JP6: SMBUS Connector**

PIN No.	Description
1	SMBCLK
2	SMBDATA

- **JP9: ATX Power Button**

<b>PIN No.</b>	<b>Description</b>
1	+3.3V
2	PWRBT#

- **JP10: ISA Connector**

<b>PIN No.</b>	<b>Description</b>	<b>PIN No.</b>	<b>Description</b>
1	BRSTDRV	2	GND
3	VCC	4	SD7
5	IRQ9	6	SD6
7	-12V	8	SD5
9	+12V	10	SD4
11	GND	12	SD3
13	MEMW#	14	SD2
15	MEMR#	16	SD1
17	IOW#	18	SD0
19	IOR#	20	IOCHRDY
21	REFRESH#	22	BAEN
23	SYSCLK	24	SA9
25	IRQ7	26	SA8
27	IRQ5	28	SA7
29	IRQ4	30	SA6
31	IRQ3	32	SA5
33	BALE	34	SA4
35	VCC	36	SA3
37	GND	38	SA2
39	IRQ10	40	SA1
41	IRQ11	42	SA0
43	IRQ12	44	VCC
45	IRQ15	46	MEMR#
47	IRQ14	48	MEMW#
49	MASTER#	50	GND
51	MEMCS16#	52	SA10
53	IOCS16#	54	SA11
55	SBHE#	56	SA12
57	BTC	58	SA13
59	SA15	60	SA14

- **JP11: IR Connector**

<b>PIN No.</b>	<b>Description</b>
1	5V
2	IRRXH
3	IRRX
4	GND
5	IRTX

- **JP12: KEYLOCK Connector**

<b>PIN No.</b>	<b>Description</b>
1	VCC
2	N/C
3	GND
4	KEYLOCK
5	GND

- **JP13: LAN Link LED**

<b>PIN No.</b>	<b>Description</b>
1	+3.3V
2	LINK#

- **JP14: LAN Speed LED**

<b>PIN No.</b>	<b>Description</b>
1	+3.3V
2	100#

- **JP15: LAN Active LED**

<b>PIN No.</b>	<b>Description</b>
1	+3.3V
2	ACTIVE#

- **JP16: IDE Active LED**

<b>PIN No.</b>	<b>Description</b>
1	+5V
2	ACTIVE#

- **JP17: SCSI LED**

PIN No.	Description
1	LED
2	+5V

- **JP19: Key Board Connector**

PIN No.	Description
1	Keyboard Clock
2	Keyboard Data
3	N/C
4	GND
5	+5V

- **JP20: LAN Connector**

PIN No.	Description
1	5V
2	LILED
3	RD+
4	RD-
5	ACTLED
6	TERMPANE
7	N/C
8	TERMPANE
9	TD+
6	TD-

## Chapter 3

# Capability Expanding

This chapter explains how you can expand capability of your CPU board in such aspects as system memory, cache memory, and CPU.

### 3-1 System Memory

Your system memory is provided by DIMM's (Dual In-line Memory Modules) on the CPU board. The CPU board contains four memory banks: Bank 0, 1, 2, 3, corresponds to connector DIMM1, DIMM2, DIMM3 and DIMM4.

The table below shows possible DIMM configurations for the memory banks.

You can also use the DIMM with parity check. The ECC (Error Checking and Correction) could be turned on if parity DIMMS are used. The ECC will correct one bit error and report two bit errors. Please be noted that the PEAK 6320A only supports the SDRAM.

DIMM 1	DIMM 2	DIMM 3	DIMM 4	Total Memory
16M	16M	16M	16M	64MB
32M	32M	Empty	Empty	64MB
32M	16M	16M	Empty	64MB
64M	Empty	Empty	Empty	64MB
32M	32M	32M	Empty	96MB
64M	32M	Empty	Empty	96MB
64M	64M	Empty	Empty	128MB
32M	32M	32M	32M	128MB
64M	64M	64M	Empty	192MB
64M	64M	16M	16M	192MB
64M	64M	64M	64M	256MB
128M	Empty	Empty	Empty	128MB
128M	128M	Empty	Empty	256MB
128M	128M	128M	Empty	384MB
128M	128M	128M	128M	512MB
256M	Empty	Empty	Empty	256MB
256M	256M	Empty	Empty	512MB
256M	256M	256M	Empty	768MB
256M	256M	256M	256M	1GB

## Installing DIMM

To install the DIMM, first make sure the two handles of the DIMM socket are in the open position, i.e. the handles stay outward. Slowly slide the DIMM modules along the plastic guides in the both ends of the socket. Then press the DIMM module down right into the socket, until a click is heard. That means the two handles automatically locked the memory modules into the right position of the DIMM socket as Figure 3-1 shows. To take away the memory module, just push the both handles outward, the memory module will be ejected by the mechanism in the socket.

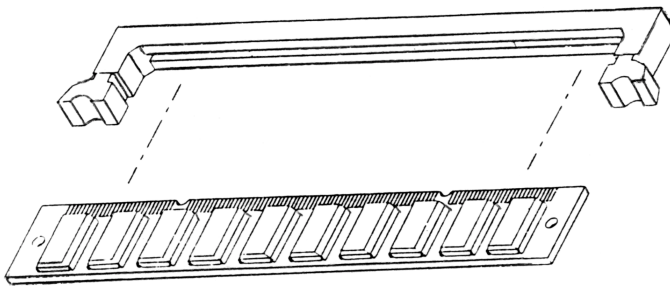

Figure 3-1 Install DIMM

### 3-2 Cache Memory

Since the second level cache has been embedded into the Pentium II CPU. You do not have to take care of either SRAM chips or SRAM modules. The built-in second level cache in the Pentium II yields much higher performance than the external ones. The cache size in the Pentium II CPU is either 256KB or 512KB. Normally, for workstation and server applications, the 256KB version is good enough. However, if your system is for heavy duty applications, the 512kB version will help a lot. Specifically for our Pentium II based SBC, the Pentium II has another version provide much better data security if combined with the DRAM ECC, please check with your vendor for various Pentium II models.

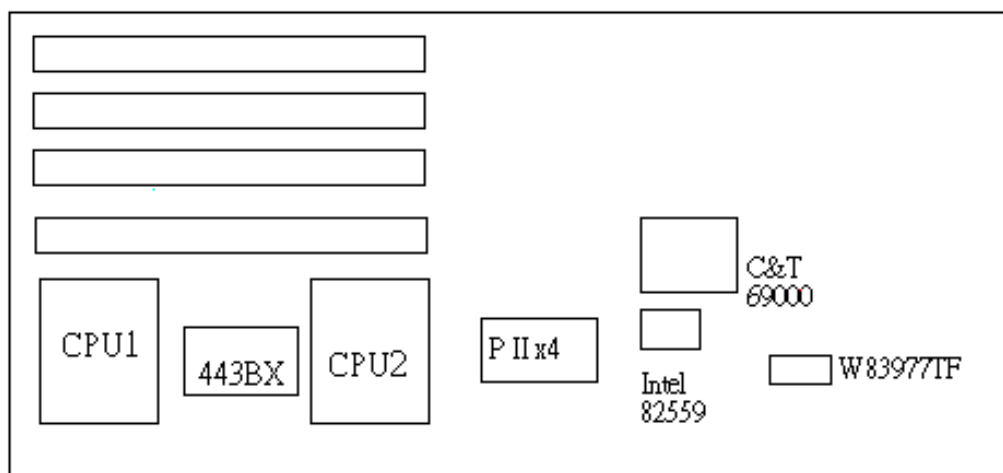

Figure 3-2 Memory Banks

The level 2 cache of the Peak 6320A is built in the Celeron/Pentium III current Celerons have 128 KB on die L2 Cache which is very fast because it's running at the CPU speed. Future Celerons/Pentium III might be upgraded to 256 KB L2 Cache.

### 3-3 Change CPU

To change the CPU, pull the handling bar of the socket upward to the other end to loosen the socket's openings. Carefully lift the existing CPU up to remove it from the socket.

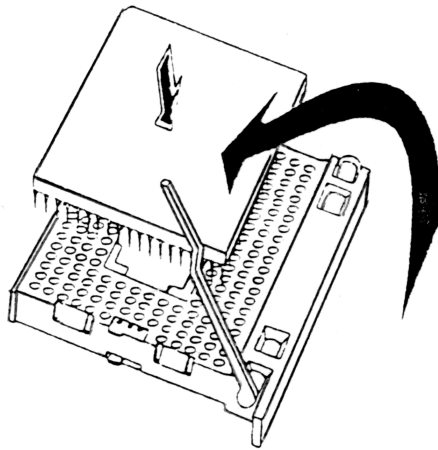

Figure 3-3 Removing CPU

Place the new CPU on the middle of the socket, orienting its beveled corner to line up with the socket's beveled corner. Make sure the pins of the CPU fit evenly to the socket openings. Replace the handling bar to fasten the CPU to the socket. Be sure to re-arrange the jumper setting for the correct external clock (66MHz or 100MHz) by (SW1.3) (SW1.4).

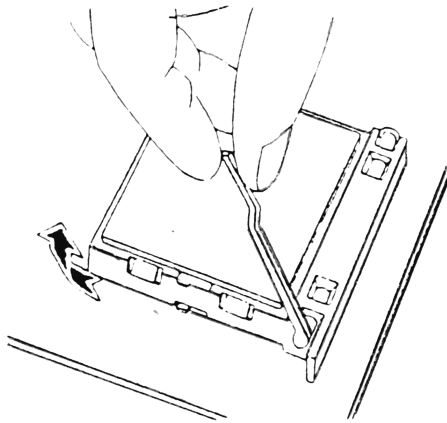

Figure 3-4 Installing CPU

## Chapter 4 AWARD BIOS Setup

Award's BIOS ROM has a built-in Setup program that allows users to modify the basic system configuration. This type of information is stored in battery-backed RAM (CMOS RAM) so that it retains the Setup information when the power is turned off.

### *Entering Setup*

Power on the computer and press <Del> immediately will allow you to enter Setup. The other way to enter Setup is to power on the computer, when the below message appears briefly at the bottom of the screen during the POST (Power On Self Test), press <Del> key or simultaneously press <Ctrl>, <Alt>, and <Esc> keys.

TO ENTER SETUP BEFORE BOOT PRESS <CTRL-ALT-ESC> OR <DEL> KEY

If the message disappears before you respond and you still wish to enter Setup, restart the system to try again by turning it OFF then ON or pressing the "RESET" button on the system case. You may also restart by simultaneously pressing <Ctrl>, <Alt>, and <Delete> keys. If you do not press the keys at the correct time and the system does not boot, an error message will be displayed and you will again be asked to,

PRESS <F1> TO CONTINUE, <CTRL-ALT-ESC> OR <DEL> TO ENTER SETUP

<i>Control Keys</i>
---------------------

Up arrow	Move to previous item
Down arrow	Move to next item
Left arrow	Move to the item in the left hand
Right arrow	Move to the item in the right hand
Esc key	Main Menu -- Quit and not save changes into CMOS Status Page Setup Menu and Option Page Setup Menu -- Exit current page and return to Main Menu
PgUp / " " key	Increase the numeric value or make changes
PgDn / "- key	Decrease the numeric value or make changes
F1 key	General help, only for Status Page Setup Menu and Option Page Setup Menu
(Shift)F2 key	Change color from total 16 colors. F2 to select color forward, (Shift) F2 to select color backward
F3 key	Reserved
F4 key	Reserved
F5 key	Restore the previous CMOS value from CMOS, only for Option Page Setup Menu
F6 key	Load the default CMOS value from BIOS default table, only for Option Page Setup Menu
F7 key	Load the Setup default , only for Option Page Setup Menu
F8 key	Reserved
F9 key	Reserved
F10 key	Save all the CMOS changes, only for Main Menu

## *Getting Help*

### **Main Menu**

The on-line description of the highlighted setup function is displayed at the bottom of the screen.

### **Status Page Setup Menu/Option Page Setup Menu**

Press F1 to pop up a small help window that describes the appropriate keys to use and the possible selections for the highlighted item. To exit the Help Window press <F1> or <Esc>.

## *The Main Menu*

Once you enter Award BIOS CMOS Setup Utility, the Main Menu (Figure 1) will appear on the screen. The Main Menu allows you to select from ten setup functions and two exit choices. Use arrow keys to select among the items and press <Enter> to accept or enter the sub-menu.

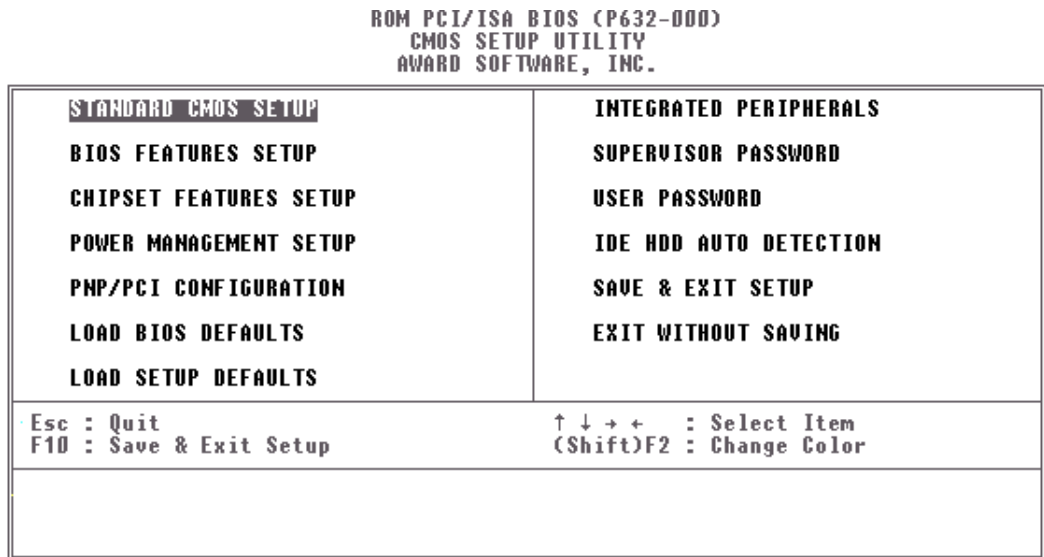

**Standard CMOS setup**

This setup page includes all the items in a standard compatible BIOS. See Page 4-7 to Page 4-10 for details.

**BIOS features setup**

This setup page includes all the items of Award special enhanced features. See Page 4-11 to Page 4-15 for details.

### **Chipset features setup**

This setup page includes all the items of chipset special features. See Page 4-16 to Page 4-20 for details.

### **Power Management setup**

This category determines how much power consumption for system after selecting below items. Default value is Disable. See Page 4-21 to Page 4-25 for details.

### **PNP/PCI CONFIGURATION**

This category specifies the assignment of all the IRQ and DMA .  
See Page 4-26 to Page 4-27 for details.

### **Load BIOS defaults**

BIOS defaults indicates the most appropriate value of the system parameter which the system would be in minimum performance. The OEM manufacturer may change the defaults through MODBIN before the binary image burn into the ROM.

### **Load setup defaults**

Chipset defaults indicates the values required by the system for the maximum performance. The OEM manufacturer may change to defaults through MODBIN before the binary image burn into the ROM.

### **Integrated Peripherals System Environment**

This category allows you to set up all the on board I/O controllers like IDE, SCSI, FDC, etc.,  
See Page 4-28 to Page 4-30

### **Password Setting**

Change, set, or disable password of supervisor or user. It allows you to limit access to the system and Setup, or just to Setup. See Page 4-31 for details.

**IDE HDD auto detection**

Automatically configure hard disk parameters. See Page 4-32 to Page 4-35.

**Save & Exit Setup**

Save CMOS value changes to CMOS and exit setup.

**Exit without saving**

Abandon all CMOS value changes and exit setup.

## Standard CMOS Setup Menu

The items in Standard CMOS Setup Menu are divided into 10 categories. Each category includes no, one or more than one setup items. Use the arrow keys to highlight the item and then use the <PgUp> or <PgDn> keys to select the value you want in each item.

Figure 2 Standard CMOS Setup Menu (Support Enhanced IDE)

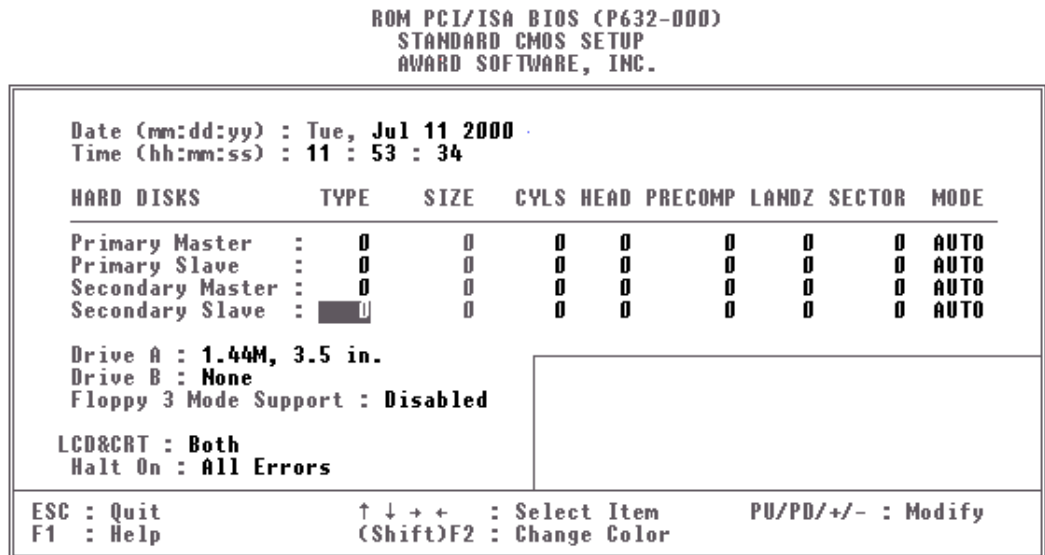

### Date

The date format is <day>, <date> <month> <year>. Press <F3> to show the calendar.

Day	The day of week, from Sun to Sat, determined by the BIOS, is read only
date	The date, from 1 to 31 (or the maximum allowed in the month), can key in the numerical / function key
month	The month, Jan through Dec
year	The year, depend on the year of BIOS

**Time**

The time format is <hour> <minute> <second>. which accepts both function key or numerical key The time is calculated based on the 24-hour military-time clock. For example, 1 p.m. is 13:00:00.

**Primary Master/Primary Slave**

The categories identify the types of drives that have been installed in the computer. There are 45 predefined types and 2 user definable types are for Enhanced IDE BIOS. Type 1 to Type 45 are predefined. Type User is user-definable.

Press PgUp/<+> or PgDn/<-> to select a numbered hard disk type or type the number and press <Enter>. Note that the specifications of your drive must match with the drive table. The hard disk will not work properly if you enter improper information for this category. If your hard disk drive type is not matched or listed, you can use Type User to define your own drive type manually.

If you select Type User, related information is asked to be entered to the following items. Enter the information directly from the keyboard and press <Enter>. This information should be provided in the documentation from your hard disk vendor or the system manufacturer.

If the controller of HDD interface is ESDI, the selection shall be type 1  
If the controller of HDD interface is SCSI, the selection shall be one  
If the controller of HDD interface is CD-ROM, the selection shall be one

CYLS.	number of cylinders
HEADS	number of heads
PRECOMP	write precom
LANDZONE	landing zone
SECTORS	number of sectors
MODE	HDD access mode

If a hard disk has not been installed select NONE and press <Enter>.

**Drive A type/Drive B type**

The category identifies the types of floppy disk drive A or drive B that have been installed in the computer.

None	No floppy drive installed
360K, 5.25 in	5-1/4 inch PC-type standard drive; 360 kilobyte capacity
1.2M, 5.25 in	5-1/4 inch AT-type high-density drive; 1.2 megabyte capacity
720K, 3.5 in	3-1/2 inch double-sided drive; 720 kilobyte capacity
1.44M, 3.5 in	3-1/2 inch double-sided drive; 1.44 megabyte capacity
2.88M, 3.5 in	3-1/2 inch double-sided drive; 2.88 megabyte capacity

**Video**

The category selects the type of adapter used for the primary system monitor that must match your video display card and monitor. Although secondary monitors are supported, you do not have to select the type in Setup.

You have two ways to boot up the system:

1. When VGA as primary and monochrome as secondary, the selection of the video type is GA Mode
2. When monochrome as primary and VGA as secondary, the selection of the video type is onochrome Mode

EGA/VGA	Enhanced Graphics Adapter/Video Graphics Array. For EGA, VGA, SEGA, or PGA monitor adapters.
CGA 40	Color Graphics Adapter, power up in 40 column mode
CGA 80	Color Graphics Adapter, power up in 80 column mode
MONO	Monochrome adapter, includes high resolution monochrome adapters

### **Error Halt**

The category determines whether the computer will stop if an error is detected during power up.

No errors	Whenever the BIOS detects a non-fatal error the system will be stopped and you will be prompted.
All errors	The system boot will not be stopped for any error that may be detected.
All, But Keyboard	The system boot will not stop for a keyboard error; it will stop for all other errors.
All, But Diskette	The system boot will not stop for a disk error; it will stop for all other errors.
All, But Disk/Key	The system boot will not stop for a keyboard or disk error; it will stop for all other errors.

### **Memory**

The category is display-only which is determined by POST (Power On Self Test) of the BIOS.

#### Base Memory

The POST of the BIOS will determine the amount of base (or conventional) memory installed in the system. The value of the base memory is typically 512K for systems with 512K memory installed on the motherboard, or 640K for systems with 640K or more memory installed on the motherboard.

#### Extended Memory

The BIOS determines how much extended memory is present during the POST. This is the amount of memory located above 1MB in the CPU's memory address map.

#### Other Memory

This refers to the memory located in the 640K to 1024K address space. This is memory that can be used for different applications. DOS uses this area to load device drivers to keep as much base memory free for application programs. Most use for this area is Shadow RAM.

**BIOS Features Setup Menu**

ROM PCI/ISA BIOS (P632-000)  
 BIOS FEATURES SETUP  
 AWARD SOFTWARE, INC.

<p>Virus Warning : Disabled                  CPU Internal Cache : Enabled                  External Cache : Enabled                  CPU L2 Cache ECC Checking : Enabled                  Processor Number Feature : Disabled                  Quick Power On Self Test : Disabled                  Boot From LAN First : Disabled                  Boot Sequence : A,C,SCSI                  Swap Floppy Drive : Disabled                  Boot Up Floppy Seek : Enabled                  Boot Up NumLock Status : On                  Gate A20 Option : Fast                  Typematic Rate Setting : Disabled                  Typematic Rate (Chars/Sec) : 6                  Typematic Delay (Msec) : 250                  Security Option : Setup                  PCI/VGA Palette Snoop : Disabled                  OS Select For DRAM &gt; 64MB : Non-OS2                  HDD S.M.A.R.T. capability : Disabled</p>	<p>Video BIOS Shadow : Enabled                  C8000-CBFFF Shadow : Disabled                  CC000-CFFFF Shadow : Disabled                  D0000-D3FFF Shadow : Disabled                  D4000-D7FFF Shadow : Disabled                  D8000-DBFFF Shadow : Disabled                  DC000-DFFFF Shadow : Disabled</p> <hr/> <p>ESC : Quit            ↑↓++ : Select Item                  F1 : Help            PU/PD/+/- : Modify                  F5 : Old Values (Shift)F2 : Color                  F6 : Load BIOS Defaults                  F7 : Load Setup Defaults</p>
--	---

**Virus Warning**

This category flashes on the screen. During and after the system boots up, any attempt to write to the boot sector or partition table of the hard disk drive will halt the system and the following error message will appear, in the mean time, you can run an anti-virus program to locate the problem.

**! WARNING !**  
 Disk boot sector is to be modified  
 Type "Y" to accept write or "N" to abort write  
 Award Software, Inc.

Enabled	Activates automatically when the system boots up causing a warning message to appear when anything attempts to access the boot sector or hard disk partition table.
Disabled	No warning message to appear when anything attempts to access the boot sector or hard disk partition table.

Note: This function is available only for DOS and other OSes that do not trap INT13.

**CPU Internal Cache/External Cache**

These two categories speed up memory access. However, it depends on CPU/chipset design. The default value is Enable. If your CPU without Internal Cache then this item "CPU Internal Cache" will not be show.

Enabled	Enable cache
Disabled	Disable cache

**Quick Power On Self Test**

This category speeds up Power On Self Test (POST) after you power on the computer. If it is set to Enable, BIOS will shorten or skip some check items during POST.

Enabled	Enable quick POST
Disabled	Normal POST

**Boot Sequence**

This category determines which drive computer searches first for the disk operating system (i.e., DOS). Default value is A,C.

C,A	System will first search for hard disk drive then floppy disk drive.
A,C	System will first search for floppy disk drive then hard disk drive.

Note: This function is only available for IDE type. For SCSI type is always boot from A.

**Boot Up Floppy Seek**

During POST, BIOS will determine if the floppy disk drive installed is 40 or 80 tracks. 360K type is 40 tracks while 720K, 1.2M and 1.44M are all 80 tracks.

Enabled	BIOS searches for floppy disk drive to determine if it is 40 or 80 tracks. Note that BIOS can not tell from 720K, 1.2M or 1.44M drive type as they are all 80 tracks.
Disabled	BIOS will not search for the type of floppy disk drive by track number. Note that there will not be any warning message if the drive installed is 360K.

### **Boot Up NumLock Status**

The default value is On.

On	Keypad is number keys
Off	Keypad is arrow keys

### **Typematic Rate Setting**

This determines the typematic rate.

Enabled	Enable typematic rate and typematic delay programming
Disabled	Disable typematic rate and typematic delay programming. The system BIOS will use default value of this 2 items and the default is controlled by keyboard.

### **Typematic Rate (Chars/Sec)**

6	6 characters per second
8	8 characters per second
10	10 characters per second
12	12 characters per second
15	15 characters per second
20	20 characters per second
24	24 characters per second
30	30 characters per second

### **Typematic Delay (Msec)**

When holding a key, the time between the first and second character displayed.

250	250 msec
500	500 msec
750	750 msec

1000	1000 msec
------	-----------

**Security Option**

This category allows you to limit access to the system and Setup, or just to Setup.

System	The system will not boot and access to Setup will be denied if the correct password is not entered at the prompt.
Setup	The system will boot, but access to Setup will be denied if the correct password is not entered at the prompt.

Note: To disable security, select PASSWORD SETTING at Main Menu and then you will be asked to enter password. Do not type anything and just press <Enter>, it will disable security. Once the security is disabled, the system will boot and you can enter Setup freely.

**PCI/VGA Palette Snoop**

It determines whether the MPEG ISA/VESA VGA Cards can work with PCI/VGA or not.

Enabled	When PCI/VGA working with MPEG ISA/VESA VGA Card.
Disabled	When PCI/VGA not working with MPEG ISA/VESA VGA Card.

**OS Select for DRAM > 64MB**

This segment is specifically created for OS/2 when DRAM is larger than 64MB. If your operating system is OS/2 and DRAM used is larger the 64MB, you have to select S 2 otherwise, non-OS2, default is NON-OS2.

**Video BIOS Shadow**

It determines whether video BIOS will be copied to RAM, however, it is optional from chipset design. Video Shadow will increase the video speed.

Enabled	Video shadow is enabled
Disabled	Video shadow is disabled

**C8000 - CFFFF Shadow/D8000 - DFFFF Shadow**

These categories determine whether optional ROM will be copied to RAM by 16K byte or 32K byte per/unit and the size depends on chipset.

Enabled	Optional shadow is enabled
Disabled	Optional shadow is disabled

Note: 1. for C8000-DFFFF option-ROM on PCI BIOS , BIOS will automatically enable the shadow RAM. User does not have to select the item.

2. IDE second channel control:

Enable :enable secondary IDE port and BIOS will assign IRQ15 for this port.

Disable: disable secondary IDE port and IRQ15 is available for other device.

The item is optional only for PCI BIOS.

3. Some of the sound cards have an onboard CD-ROM controller which uses IDE Secondary Port. In order to avoid PCI IDE conflict, the IDE secondary channel control has to select isable then CD- ROM can work.

## Chipset Features Setup Menu

Since the features in this section are related to the chipset in the CPU board and all are optimized, you are not recommended to change the default settings in the setup table, unless you know very detailed of the chipset features.

```

ROM PCI/ISA BIOS (P632-000)
CHIPSET FEATURES SETUP
AWARD SOFTWARE, INC.

Auto Configuration      : Enabled
EDO DRAM Speed Selection : 60ns
EDO CAS# MA Wait State  : 2
EDO RAS# Wait State     : 1
SDRAM RAS-to-CAS Delay  : 3
SDRAM RAS Precharge Time : 3
SDRAM CAS latency Time  : 3
SDRAM Precharge Control : Disabled
DRAM Data Integrity Mode : Non-ECC
System BIOS Cacheable   : Disabled
Video BIOS Cacheable    : Disabled

8 Bit I/O Recovery Time : 1
16 Bit I/O Recovery Time : 1
Memory Hole At 15M-16M  : Disabled
Passive Release          : Enabled
Delayed Transaction      : Enabled
AGP Aperture Size (MB)  : 64

CPU Warning Temperature : 120
Current System Temp.    :
Current CPU1 Temperature :
Current CPU2 Temperature :
Current CUFAN1 Speed    :
Current CUFAN2 Speed    :
CPU1 Vcore :           Utt
+ 3.3V :                + 5 V
+12 V :                 -12 V :-
CPU2 Vcore :

Warning Temp. Beep      : Enabled

ESC : Quit           ↑↓++ : Select Item
F1  : Help          PU/PD/+- : Modify
F5  : Old Values   (Shift)F2 : Color
F6  : Load BIOS Defaults
F7  : Load Setup Defaults
    
```

This section describes features of the Intel 440BX PCIset. If your system contains a different chipset, this section will bear little resemblance to what you see on your screen.

ADVANCED OPTIONS. The parameters in this screen are for system designers, service personnel, and technically competent users only. Do not reset these values unless you understand the consequences of your changes.

NOTE: This chapter describes all fields offered by Award Software in this screen. Your system board designer may omit or modify some fields.

### Auto Configuration

Auto Configuration selects predetermined optimal values of chipset parameters. When Disabled, chipset parameters revert to setup information stored in CMOS. Many fields in this screen are not available when Auto Configuration is Enabled.

The Choice: Enabled, Disabled.

**EDO DRAM Speed Selection**

The DRAM timing is controlled by the DRAM Timing Registers. The timings programmed into this register are dependent on the system design. Slower rates may be required in certain system designs to support loose layouts or slower memory.

50ns	DRAM Timing Type.
60ns	DRAM Timing Type.

**EDO CAS# MA Wait State**

You could select the timing control type of EDO DRAM CAS MA (memory address bus).  
The choice: 1, 2.

**EDO RAS# MA Wait State**

You could select the timing control type of EDO DRAM RAS MA (memory address bus).  
The choice: 1, 2.

**SDRAM RAS-to-CAS Delay**

You can select RAS to CAS Delay time in HCLKs of 2/2 or 3/3. The system board designer should set the values in this field, depending on the DRAM installed. Do not change the values in this field unless you change specifications of the installed DRAM or the installed CPU. The Choice: 2, 3.

**SDRAM RAS Precharge Time**

Defines the length of time for Row Address Strobe is allowed to precharge. The Choice: 2, 3

**SDRAM CAS latency Time**

You can select CAS latency time in HCLKs of 2/2 or 3/3. The system board designer should set the values in this field, depending on the DRAM installed. Do not change the values in this field unless you change specifications of the installed DRAM or the installed CPU. The choice: 2, 3.

**DRAM Data Integrity Mode**

Select Parity or ECC (error-correcting code), according to the type of installed DRAM. The Choice: Non-ECC, ECC.

**System BIOS Cacheable**

Select Enabled allows caching of the system BIOS ROM at F000h-FFFFh, resulting in better system performance. However, if any program writes to this memory area, a system error may result.

Enabled	BIOS access cached
Disabled	BIOS access not cached

**Video BIOS Cacheable**

Select Enabled allows caching of the video BIOS ROM at C0000h-F7FFFh, resulting in better video performance. However, if any program writes to this memory area, a system error may result.

Enabled	Video BIOS access cached
Disabled	Video BIOS access not cached

**Video RAM Cacheable**

Select Enabled allows caching of the video RAM , resulting in better system performance. However, if any program writes to this memory area, a system error may result.

**8 Bit I/O Recovery Time**

The recovery time is the length of time, measured in CPU clocks, which the system will delay after the completion of an input/output request. This delay takes place because the CPU is operating so much faster than the input/output bus that the CPU must be delayed to allow for the completion of the I/O. This item allows you to determine the recovery time allowed for 8 bit I/O. Choices are from NA, 1 to 8 CPU clocks.

**16 Bit I/O Recovery Time**

This item allows you to determine the recovery time allowed for 16 bit I/O. Choices are from NA, 1 to 4 CPU clocks.

**Memory Hole At 15M-16M**

In order to improve performance, certain space in memory can be reserved for ISA cards. This memory must be mapped into the memory space below 16 MB.

Enabled	Memory hole supported.
---------	------------------------

Disabled	Memory hole not supported.
----------	----------------------------

**Passive Release**

When Enabled, CPU to PCI bus accesses are allowed during passive release. Otherwise, the arbiter only accepts another PCI master access to local DRAM. The choice: Enabled, Disabled.

**Delayed Transaction**

The chipset has an embedded 32-bit posted write buffer to support delay transactions cycles. Select Enabled to support compliance with PCI specification version 2.1. The choice: Enabled, Disabled.

**AGP Aperture Size (MB)**

Select the size of the Accelerated Graphics Port (AGP) aperture. The aperture is a portion of the PCI memory address range dedicated for graphics memory address space. Host cycles that hit the aperture range are forwarded to the AGP without any translation. See [www.agpforum.org](http://www.agpforum.org) for AGP information. The choice: 4, 8, 16, 32, 64, 128, 256

**Auto Detect DIMM/PCI Clk**

This item auto detect the clock generator. The unused pins of DIMM/PCI Clk are disabled. The amplitudes of the radiated electromagnetic emissions are reduced. Choices: Enabled, Disabled.

**Spread Spectrum Modulated**

The Clock Generator generates a clock that is frequency modulated in order to increase the bandwidth that is occupies. By increasing the bandwidth of the fundamental and its harmonics, the amplitudes of the radiated electromagnetic emissions are reduced. Choices: Enabled, Disabled.

## Power Management Setup

The Power management setup will appear on your screen like this:

```

ROM PCI/ISA BIOS (P632-000)
POWER MANAGEMENT SETUP
AWARD SOFTWARE, INC.

ACPI function           : Disabled
Power Management       : User Define
PM Control by APM      : Yes
Video Off Method       : U/H SYNC+Blank
Video Off After        : Standby
Doze Mode              : Disable
Standby Mode           : Disable
Suspend Mode           : Disable
HDD Power Down         : Disable
Throttle Duty Cycle    : 62.5%
PCI/UGA Act-Monitor    : Disabled
Soft-Off by PWR-BTTN  : Instant-Off
PowerOn by Ring        : Disabled
IRQ 8 Break Suspend    : Disabled

** Reload Global Timer Events **
IRQ[3-7,9-15],NMI     : Disabled
Primary IDE 0          : Disabled
Primary IDE 1          : Disabled
Secondary IDE 0        : Disabled
Secondary IDE 1        : Disabled
Floppy Disk            : Disabled
Serial Port            : Disabled
Parallel Port          : Disabled

ESC : Quit           ↑↓↓ : Select Item
F1  : Help           PU/PD/+- : Modify
F5  : Old Values    (Shift)F2 : Color
F6  : Load BIOS     Defaults
F7  : Load Setup     Defaults
    
```

**Power Management**

This category determines how much power consumption for system after selecting below items. Default value is Disable. The following pages tell you the options of each item & describe the meanings of each options.

Item	Options	Descriptions
A.Power Management	1. Disable	Global Power Management will be disabled
	2. User Define	Users can configure their own power management
	3. Min Saving	Pre-defined timer values are used such that all timers are in their MAX value
	4. Max Saving	Pre-defined timer values are used such that all timers MIN value
B. Video Off Option	1. Always On	System BIOS will never turn off the screen
	2. Suspend->Off	Screen off when system is in SUSPEND mode
	3. Susp, stby->Off	Screen off when system is in STANDBY or SUSPEND mode
	4. All Modes ->Off	Screen off when system is in DOZE, STANDBY or SUSPEND mode
C. Video Off Method	1. Blank Screen	The system BIOS will only blanks off the screen when disabling video
	2. V/H SYN C+Blank	In addition to (1), BIOS will also turn off the V-SYNC & H-SYNC signals from VGA cards to monitor
	3. DPMS Supported	This function is enabled for only the VGA card supporting DPMS
		Note: Green monitors detect the V/H SYNC signals to turn off its electron gun

D. Switch Function	1. Break	The External Suspend Switch is "reak"
	2. Wake	The External Suspend Switch is "ake"
	2. 1 Min 2 Min 4 Min 6 Min 8 Min 10 Min 20 Min 30 Min 40 Min 1 Hr	Defines the continuous idle time before the system entering DOZE mode.  if any item defined in (J) is enabled & active, DOZE timer will be reloaded
		Note: Normally,STANDBY mode puts the system into low speed or 8 MHz, screen may be off depend on (E)
E. Doze Speed(div by) Stdby speed (div by)	1/8 2/8 3/8 4/8 5/8 6/8 7/8 8/8	System full speed could be divided by the optional integers, the bigger the number the slower the speed under Doze or standby mode
F. Modem Use IRQ	3,4,5,7,9 4,10,11,NA	For external modem, 3 or 4 will be used for card type modem. It is up to card definition. Default is 3.
G. Standby Mode (*) Remark 1	1. Disable	System will never enter STANDBY mode
	2. 10 sec 1 Min 10 Min 30 Min 1 Hour 2 Hour 20 Min	Defines the continuous idle time before the system entering STANDBY mode.  if any item defined in (J) is enabled & active, STANDBY timer will be reloaded
		Note: Normally,STANDBY mode puts the system into low speed or 8 MHz, screen may be off depend on (E)

H. Doze (*) Remark 1	1. Disable	System will never enter STANDBY mode
	2. 1 Min 2 Min 4 Min 6 Min 8 Min 10 Min 20 Min 30 Min 40 Min 1 Hr	Defines the continuous idle time before the system entering STANDBY mode.  if any item defined in (J) is enabled & active, STANDBY timer will be reloaded
		Note: Normally,STANDBY mode puts the system into low speed or 8 MHz, screen may be off depend on (E)
I. Suspend Mode (*) Remark 1	1. Disable	System will never enter SUSPEND mode
	2. 1 Min 2 Min 4 Min 6 Min 8 Min 10 Min 20 Min 30 Min 40 Min 1 Hr	Defines the continuous idle time before the system entering SUSPEND mode.  if any item defined in (J) is enabled & active, SUSPEND timer will be reloaded
		Note: Normally,SUSPEND mode puts the system into low speed or 8 MHz, clock is stopped, screen may be off depend on (E)
J. HDD Off After:	1. Disable	HDD motor will not off
	2. 10 Sec 1 Min 10 Min 30 Min 1 Hour 2 Hour 4 Hour	Defines the continuous HDD idle time before the HDD entering power saving mode (motor off)

K. VGA Activity	1. Disabled	
IRQ3 (COM 2) IRQ4 (COM 1) IRQ5 (LPT 2) IRQ6 (Floppy Disk) IRQ7 (LPT 1) IRQ8 (RTC Alarm) IRQ9 (IRQ2 Redir) IRQ10 (Reserved) IRQ11 (Reserved) IRQ12 (PS/2 Mouse) IRQ13 (Coprocessor) IRQ14 (Hard Disk) IRQ15 (Reserved)	2. Enabled	
L. Power Bottom Over Ride	1. Delay 4 Sec 2. Instant off	

\* Remark 1: All items mark with (\*) in this menu, will be loaded with predefined values as long as the item Power Management is not configured to User Defined'

These items are:

Item System Doze , System Standby & System Suspend'

# Remark 2: Although the item HDD Power Down' is not controlled by item Power Management in terms of timer value, the HDD (s) will not power down if the global power management is disabled!

**PnP/PCI Configuration**

This section describes configuring the PCI bus system. PCI, or **P**eripheral **C**omponent **I**nterconnect, is a system which allows I/O devices to operate at speeds nearing the speed the CPU itself uses when communicating with its own special components. This section covers some very technical items and it is strongly recommended that only experienced users should make any changes to the default settings.

ROM PCI/ISA BIOS (P632-000)  
 PNP/PCI CONFIGURATION  
 AWARD SOFTWARE, INC.

PNP OS Installed : <b>Yes</b>	Slot 1 Use IRQ No. : <b>Auto</b>
Resources Controlled By : <b>Manual</b>	Slot 2 Use IRQ No. : <b>Auto</b>
Reset Configuration Data : <b>Disabled</b>	Slot 3 Use IRQ No. : <b>Auto</b>
	Slot 4 Use IRQ No. : <b>Auto</b>
IRQ-3 assigned to : <b>PCI/ISA PnP</b>	Used MEM base addr : <b>000</b>
IRQ-4 assigned to : <b>PCI/ISA PnP</b>	Assign IRQ For USB : <b>Disabled</b>
IRQ-5 assigned to : <b>PCI/ISA PnP</b>	PCI Latency Timer(CLK): <b>0</b>
IRQ-7 assigned to : <b>PCI/ISA PnP</b>	
IRQ-9 assigned to : <b>PCI/ISA PnP</b>	
IRQ-10 assigned to : <b>PCI/ISA PnP</b>	
IRQ-11 assigned to : <b>PCI/ISA PnP</b>	
IRQ-12 assigned to : <b>PCI/ISA PnP</b>	
IRQ-14 assigned to : <b>PCI/ISA PnP</b>	
IRQ-15 assigned to : <b>PCI/ISA PnP</b>	
DMA-0 assigned to : <b>PCI/ISA PnP</b>	
DMA-1 assigned to : <b>PCI/ISA PnP</b>	
DMA-3 assigned to : <b>PCI/ISA PnP</b>	
DMA-5 assigned to : <b>PCI/ISA PnP</b>	
DMA-6 assigned to : <b>PCI/ISA PnP</b>	
DMA-7 assigned to : <b>PCI/ISA PnP</b>	
	ESC : Quit            ↑↓↓+ : Select Item
	F1 : Help            PU/PD/+/- : Modify
	F5 : Old Values (Shift)F2 : Color
	F6 : Load BIOS Defaults
	F7 : Load Setup Defaults

**PNP OS Installed**

This item allows you to determine install PnP OS or not.  
 Choices are Yes and No.

### **Resource Controlled by**

The Award Plug and Play BIOS has the capacity to automatically configure all of the boot and Plug and Play compatible devices. However, this capability means absolutely nothing unless you are using a Plug and Play operating system such as Windows® 95. Choices are *Auto* and *Manual* (default).

### **Reset Configuration Data**

This item allows you to determine reset the configuration data or not. Choices are *Enabled* and *Disabled* (default).

### **IRQ/DMA Assigned To**

This item allows you to determine the IRQ / DMA assigned to the ISA bus and is not available to any PCI slot. (Legacy ISA) or PnP for both ISA and PCI. Choices are *Legacy ISA* and *PCI/ISA PnP*.

### **PCI IRQ Activated by**

This sets the method by which the PCI bus recognizes that an IRQ service is being requested by a device. Under all circumstances, you should retain the default configuration unless advised otherwise by your system manufacturer. Choices are *Level* (default) and *Edge*.

## Integrated Peripherals

ROM PCI/ISA BIOS (P632-000) INTEGRATED PERIPHERALS AWARD SOFTWARE, INC.	
<pre> IDE HDD Block Mode      : Enabled IDE Primary Master PIO  : Auto IDE Primary Slave PIO   : Auto IDE Secondary Master PIO: Auto IDE Secondary Slave PIO : Auto IDE Primary Master UDMA : Disabled IDE Primary Slave UDMA  : Disabled IDE Secondary Master UDMA: Disabled IDE Secondary Slave UDMA: Disabled On-Chip Primary PCI IDE: Enabled On-Chip Secondary PCI IDE: Enabled Onboard PCI SCSI Chip  : Enabled USB Keyboard Support    : Disabled Init Display First     : PCI Slot           </pre>	<pre> UART2 Duplex Mode      : Half RxD , TxD Active      : Hi,Lo IR Transmission delay  : Enabled Onboard Parallel Port  : Parallel Port Mode     : ECP Mode Use DMA      : 3 EPP Mode Select       : EPP1.7           </pre>
<pre> KBC input clock        : 6 MHz Onboard FDC Controller : Enabled Onboard Serial Port 1  : Disabled Onboard Serial Port 2  : UART Mode Select      :           </pre>	<pre> ESC : Quit           ↑↓↓+ : Select Item F1  : Help           PU/PD/+/- : Modify F5  : Old Values    (Shift)F2 : Color F6  : Load BIOS Defaults F7  : Load Setup Defaults           </pre>

### IDE HDD Block Mode

This allows your hard disk controller to use the fast block mode to transfer data to and from your hard disk drive (HDD).

Enabled	IDE controller uses block mode.
Disabled (Default)	IDE controller uses standard mode.

### IDE Primary/Secondary Master/Slave PIO

The four IDE PIO (Programmed Input/Output) fields let you set a PIO mode (0-4) for each of the four IDE devices that the onboard IDE interface supports. Modes 0 through 4 provide successively increased performance. In Auto mode, the system automatically determines the best mode for each device.

### **IDE Primary/Secondary Master/Slave UDMA**

Ultra DMA/33 implementation is possible only if your IDE hard drive supports it and the operating environment includes a DMA driver (Windows 95 OSR2 or a third-party IDE bus master driver). If your hard drive and your system software both support Ultra DMA/33, select Auto to enable BIOS support. The Choice: Auto (Default), Disabled

### **On-Chip Primary/Secondary PCI IDE**

The integrated peripheral controller contains an IDE interface with support for two IDE channels. Select Enabled (Default) to activate each channel separately.

### **Onboard PCI SCSI Chip**

This item allows you to determine whether onboard PCI SCSI chip is enabled (Default) or not.

### **USB Keyboard Support**

Select Enabled if your system contains a Universal Serial Bus (USB) controller and you have a USB keyboard. The Choice: Enabled, Disabled (Default).

### **Onboard FDC Controller**

Select Enabled if your system has a floppy disk controller (FDC) installed on the system board and you wish to use it. If you install and-in FDC or the system has no floppy drive, select Disabled in this field. Choices: Enabled (Default), Disabled.

### **Onboard Serial Port 1/Port 2**

This item allows you to determine access onboard serial port 1/port 2 controller with which I/O address. The Choice: 3F8/IRQ4, 2F8/IRQ3, 3E8/IRQ4, 2F8/IRQ3, Disabled, Auto (Default).

### **UART 2 Mode**

This item allows you to determine which Infra Red (IR) function of onboard I/O chip. The Choice: Standard (Default), IrDA1.0, ASK-IR, IrDA1.1

**Duplex Select**

This item allows you to select the IR function when you select the UART 2 Mode is IrDA1.0, ASK-IR, IrDA1.1  
Choices are Half, Full.

**TxD, RxD Active**

This item allows you to determine the active of RxD, TxD.  
Choices are Hi, Lo, Hi, Lo

**Onboard Parallel Port**

Select a logical LPT port name and matching address for the physical parallel (printer) port. The choice: 378H/IRQ7 (Default), 278H/IRQ5, 3BCH/IRQ7, Disabled.

**Parallel Port Mode**

Select an operating mode for the onboard parallel port. Select Compatible or Extended unless you are certain both your hardware and software support EPP or ECP mode.  
The choice: SPP, ECP+EPP1.7, EPP1.7+SPP, EPP1.9+SPP, ECP, ECP+EPP1.9 (Default), and Normal.

**ECP Mode Use DMA**

Select a DMA channel for the port.  
Choices are 3 (Default), 1.

## *Supervisor/User Password Setting*

You can set either supervisor or user password, or both of them. The differences between are:

supervisor password : can enter and change the options of the setup menus.  
user password : just can enter but do not have the right to change the options of the setup menus.

When you select this function, the following message will appear at the center of the screen to assist you in creating a password.

ENTER PASSWORD:

Type the password, up to eight characters in length, and press <Enter>. The password typed now will clear any previously entered password from CMOS memory. You will be asked to confirm the password. Type the password again and press <Enter>. You may also press <Esc> to abort the selection and not enter a password.

To disable a password, just press <Enter> when you are prompted to enter the password. A message will confirm the password will be disabled. Once the password is disabled, the system will boot and you can enter Setup freely.

PASSWORD DISABLED.

When a password has been enabled, you will be prompted to enter it every time you try to enter Setup. This prevents an unauthorized person from changing any part of your system configuration.

Additionally, when a password is enabled, you can also require the BIOS to request a password every time your system is rebooted. This would prevent unauthorized use of your computer.

You determine when the password is required within the BIOS Features Setup Menu and its Security option (see Section 4). If the Security option is set to `system` the password will be required both at boot and at entry to Setup. If set to `setup` prompting only occurs when trying to enter Setup.

## IDE HDD Auto Detection

The Enhance IDE features was included in all Award BIOS. Below is a brief description of this feature.

1. Setup Changes

<I> Auto-detection

BIOS setup will display all possible modes that supported by the HDD including NORMAL, LBA & LARGE.

if HDD does not support LBA modes, no BA ption will be shown. Users can select a mode which is appropriate for them.

ROM/PCI/ISA BOPS (2XXXXXXXX)  
CMOS SETUP UTILITY  
AWARD SOFTWARE, INC.

HARD DISKS   TYPE   SIZE   CYLS   HEAD   PRECOMP   LANDZ   SECTOR   MODE

Primary Master :

Select Primary Master Option (N = Skip) : N

OPTION	SIZE	CYLS	HEADS	PRECOMP	LANDZONE	SECTORS	MODE
1(Y)	516	1120	16	65535	1119	59	NORMAL
2	516	524	32	0	1119	63	LBA
3	516	560	32	65535	1119	59	LARGE

<II> Standard CMOS Setup

		<u>CYLS</u>	<u>Heads</u>	<u>Precomp</u>	<u>Landzone</u>	<u>Sector</u>	<u>Mode</u>
Primary Master:	User (516MB)	1120	16	65535	1119	59	Normal
Primary Slave:	None (203MB)	684	16	65535	685	38	-----
Secondary Master:	None	0	0	0	0	0	0

---

BIOS Setup 4-33



The maximum HDD size supported by LBA mode is 8.4 Gigabytes which is obtained by the following formula:

$$\begin{array}{r} \text{no. Cylinder} \qquad \qquad \qquad ( 1024) \\ \times \text{ no. Head} \qquad \qquad \qquad ( 255) \\ \times \text{ no. Sector} \qquad \qquad \qquad ( 63) \\ \times \text{ bytes per sector} \qquad \qquad \qquad ( 512) \\ \hline \qquad \qquad \qquad \qquad \qquad \qquad 8.4 \text{ Gigabytes} \end{array}$$

LARGE mode

Extended HDD access mode supported by Award Software.

Some IDE HDDs contain more than 1024 cylinder without LBA support (in some cases, user do not want LBA). The Award BIOS provides another alternative to support these kinds of HDD!

Example of LARGE mode:

<u>CYLS.</u>	<u>HEADS</u>	<u>SECTOR</u>	<u>MODE</u>
1120	16	59	NORMAL
560	32	59	LARGE

BIOS tricks DOS (or other OS) that the number of cylinders is less than 1024 by dividing it by 2. At the same time, the number of heads is multiplied by 2. A reverse transformation process will be made inside INT13h in order to access the right HDD address the right HDD address!

Maximum HDD size:

$$\begin{array}{r} \text{no. Cylinder} \qquad \qquad \qquad ( 1024) \\ \times \text{ no. Head} \qquad \qquad \qquad ( 32) \\ \times \text{ no. Sector} \qquad \qquad \qquad ( 63) \\ \times \text{ bytes per sector} \qquad \qquad \qquad ( 512) \\ \hline \qquad \qquad \qquad \qquad \qquad \qquad 1 \text{ Gigabytes} \end{array}$$



(3) Remarks

To support LBA or LARGE mode of HDDs, there must be some softwares involved. All these softwares are located in the Award HDD Service Routine(INT 13h). It may be failed to access a HDD with LBA (LARGE) mode selected if you are running under a Operating System which replaces the whole INT 13h.

## *Power-On Boot*

After you have made all the changes to CMOS values and the system cannot boot with the CMOS values selected in Setup, restart the system by turning it OFF then ON or Pressing the "RESET" button on the system case. You may also restart by simultaneously press <Ctrl>, <Alt>, and <Delete> keys. Upon restart the system, immediately press <Insert> to load BIOS default CMOS value for boot up.

## *BIOS Reference - POST Message*

During the Power On Self Test (POST), if the BIOS detects an error requiring you to do something to fix, it will either sound a beep code or display a message.

If a message is displayed, it will be accompanied by:

PRESS F1 TO CONTINUE, CTRL-ALT-ESC OR DEL TO ENTER SETUP

### **POST Beep**

Currently there is only one beep code in BIOS. This code indicates that a video error has occurred and the BIOS cannot initialize the video screen to display any additional information. This beep code consists of a single long beep followed by two short beeps.

### **Error Messages**

One or more of the following messages may be displayed if the BIOS detects an error during the POST. This list includes messages for both the ISA and the EISA BIOS.

#### **CMOS BATTERY HAS FAILED**

CMOS battery is no longer functional. It should be replaced.

#### **CMOS CHECKSUM ERROR**

Checksum of CMOS is incorrect. This can indicate that CMOS has become corrupt. This error may have been caused by a weak battery. Check the battery and replace if necessary.

#### **DISK BOOT FAILURE, INSERT SYSTEM DISK AND PRESS ENTER**

No boot device was found. This could mean that either a boot drive was not detected or the drive does not contain proper system boot files. Insert a system disk into Drive A: and press <Enter>. If you assumed the system would boot from the hard drive, make sure the controller is inserted correctly and all cables are properly attached. Also be sure the disk is formatted as a boot device. Then reboot the system.

#### **DISKETTE DRIVES OR TYPES MISMATCH ERROR - RUN SETUP**

Type of diskette drive installed in the system is different from the CMOS definition. Run Setup to reconfigure the drive type correctly.

**DISPLAY SWITCH IS SET INCORRECTLY**

Display switch on the motherboard can be set to either monochrome or color. This indicates the switch is set to a different setting than indicated in Setup. Determine which setting is correct, and then either turn off the system and change the jumper, or enter Setup and change the VIDEO selection.

**DISPLAY TYPE HAS CHANGED SINCE LAST BOOT**

Since last powering off the system, the display adapter has been changed. You must configure the system for the new display type.

**EISA Configuration Checksum Error**

**PLEASE RUN EISA CONFIGURATION UTILITY**

The EISA non-volatile RAM checksum is incorrect or cannot correctly read the EISA slot. This can indicate either the EISA non-volatile memory has become corrupt or the slot has been configured incorrectly. Also be sure the card is installed firmly in the slot.

**EISA Configuration Is Not Complete**

**PLEASE RUN EISA CONFIGURATION UTILITY**

The slot configuration information stored in the EISA non-volatile memory is incomplete.

Note: When either of these errors appear, the system will boot in ISA mode, which allows you to run the EISA Configuration Utility.
---

**ERROR ENCOUNTERED INITIALIZING HARD DRIVE**

Hard drive cannot be initialized. Be sure the adapter is installed correctly and all cables are correctly and firmly attached. Also be sure the correct hard drive type is selected in Setup.

**ERROR INITIALIZING HARD DISK CONTROLLER**

Cannot initialize controller. Make sure the cord is correctly and firmly installed in the bus. Be sure the correct hard drive type is selected in Setup. Also check to see if any jumper needs to be set correctly on the hard drive.

**FLOPPY DISK CNTRLR ERROR OR NO CNTRLR PRESENT**

Cannot find or initialize the floppy drive controller. make sure the controller is installed correctly and firmly. If there are no floppy drives installed, be sure the Diskette Drive selection in Setup is set to NONE.

**Invalid EISA Configuration**

**PLEASE RUN EISA CONFIGURATION UTILITY**

The non-volatile memory containing EISA configuration information was programmed incorrectly or has become corrupt. Re-run EISA configuration utility to correctly program the memory.

NOTE: When this error appears, the system will boot in ISA mode, which allows you to run the EISA Configuration Utility.
--

**KEYBOARD ERROR OR NO KEYBOARD PRESENT**

Cannot initialize the keyboard. Make sure the keyboard is attached correctly and no keys are being pressed during the boot.

If you are purposely configuring the system without a keyboard, set the error halt condition in Setup to HALT ON ALL, BUT KEYBOARD. This will cause the BIOS to ignore the missing keyboard and continue the boot.

**MEMORY ADDRESS ERROR AT ...**

Indicates a memory address error at a specific location. You can use this location along with the memory map for your system to find and replace the bad memory chips.

**MEMORY PARITY ERROR AT ...**

Indicates a memory parity error at a specific location. You can use this location along with the memory map for your system to find and replace the bad memory chips.

**MEMORY SIZE HAS CHANGED SINCE LAST BOOT**

Memory has been added or removed since the last boot. In EISA mode use Configuration Utility to reconfigure the memory configuration. In ISA mode enter Setup and enter the new memory size in the memory fields.

**MEMORY VERIFY ERROR AT ...**

Indicates an error verifying a value already written to memory. Use the location along with your system's memory map to locate the bad chip.

**OFFENDING ADDRESS NOT FOUND**

This message is used in conjunction with the I/O CHANNEL CHECK and RAM PARITY ERROR messages when the segment that has caused the problem cannot be isolated.

**OFFENDING SEGMENT:**

This message is used in conjunction with the I/O CHANNEL CHECK and RAM PARITY ERROR messages when the segment that has caused the problem has been isolated.

**PRESS A KEY TO REBOOT**

This will be displayed at the bottom screen when an error occurs that requires you to reboot. Press any key and the system will reboot.

**PRESS F1 TO DISABLE NMI, F2 TO REBOOT**

When BIOS detects a Non-maskable Interrupt condition during boot, this will allow you to disable the NMI and continue to boot, or you can reboot the system with the NMI enabled.

**RAM PARITY ERROR - CHECKING FOR SEGMENT ...**

Indicates a parity error in Random Access Memory.

**SHOULD BE EMPTY BUT EISA BOARD FOUND  
PLEASE RUN EISA CONFIGURATION UTILITY**

A valid board ID was found in a slot that was configured as having no board ID.

NOTE; When this error appears, the system will boot in ISA mode, which allows you to run the EISA Configuration Utility.
--

**SHOULD HAVE EISA BOARD BUT NOT FOUND**  
**PLEASE RUN EISA CONFIGURATION UTILITY**

The board installed is not responding to the ID request, or no board ID has been found in the indicated slot.

NOTE: When this error appears, the system will boot in ISA mode, which allows you to run the EISA Configuration Utility.

**SLOT NOT EMPTY**

Indicates that a slot designated as empty by the EISA Configuration Utility actually contains a board.

NOTE: When this error appears, the system will boot in ISA mode, which allows you to run the EISA Configuration Utility.

**SYSTEM HALTED, (CTRL-ALT-DEL) TO REBOOT ...**

Indicates the present boot attempt has been aborted and the system must be rebooted. Press and hold down the CTRL and ALT keys and press DEL.

**WRONG BOARD IN SLOT**  
**PLEASE RUN EISA CONFIGURATION UTILITY**

The board ID does not match the ID stored in the EISA non-volatile memory.

NOTE: When this error appears, the system will boot in ISA mode, which allows you to run the EISA Configuration utility.

## BIOS Reference - POST Codes

**Note:** EISA POST codes are typically output to port address 300h.  
ISA POST codes are output to port address 80h.

POST (hex)	Description
C0	1. Turn off OEM specific cache, shadow... 2. Initialize all the standard devices with default values standard devices includes: -DMA controller (8237) -Programmable Interrupt Controller (8259) -Programmable Interval Timer (8254) -RTC chip
C1	Auto-detection of onboard DRAM & Cache
C3	1. Test system BIOS checksum 2. Test the first 256K DRAM 3. Expand the compressed codes into temporary DRAM area including the compressed System BIOS & Option ROMs
C5	Copy the BIOS from ROM into E0000-FFFFFF shadow RAM so that POST will go faster
01-02	Reserved
03	Initialize EISA registers (EISA BIOS only)
04	Reserved
05	1. Keyboard Controller Self-Test 2. Enable Keyboard Interface
06	Reserved
07	Verifies CMOS basic R/W functionality
BE	Program defaults values into chipset according to the MODBINable Chipset Default Table
09	1. Program the configuration register of Cyrix CPU according to the MODBINable Cyrix Register Table 2. OEM specific cache initialization (if needed)

0A	<ol style="list-style-type: none"><li>1. Initialize the first 32 interrupt vectors with corresponding Interrupt handlers Initialize INT no from 33-120 with Dummy(Suprious) Interrupt Handler</li><li>2. Issue CPUID instruction to identify CPU type</li><li>3. Early Power Management initialization (OEM specific)</li></ol>
----	---

✿ **This POST code is for boot block**

<b>POST (hex)</b>	<b>Description</b>
C0	1. Turn off OEM specific cache, shadow... 2. Initialize all the standard devices with default values standard devices includes: -DMA controller (8237) -Programmable Interrupt Controller (8259) -Programmable Interval Timer (8254) -RTC chip
C1	Auto-detection of onboard DRAM & Cache
C3	Checking checksum of compressed code
C5	Copy the BIOS from ROM into E0000-FFFFFF shadow RAM so that POST will go faster
01	Clear base memory 0~640K
0C	Initial interrupt vector 00-1FH
0D	Initial ISA VGA
41H	Enable FDD and detect media type
FFH	Boot from FDD

✿ **This page is for Non-Compressed Version only**

01-02	Reserved
C0	Turn off OEM specific cache, shadow...
03	1. Initialize EISA registers (EISA BIOS only) 2. Initialize all the standard devices with default values Standard devices includes: -DMA controller (8237) -Programmable Interrupt Controller (8259) -Programmable Interval Timer (8254) -RTC chip
04	Reserved
05	1. Keyboard Controller Self-Test 2. Enable Keyboard Interface
06	Reserved
07	Verifies CMOS basic R/W functionality
BE	Program defaults values into chipset according to the MODBINable Chipset Default Table
C1	Auto-detection of onboard DRAM & Cache
C5	Copy the BIOS from ROM into E0000-FFFFFF shadow RAM so that POST will go faster
08	Test the first 256K DRAM
09	1. Program the configuration register of Cyrix CPU according to the MODBINable Cyrix Register Table 2. OEM specific cache initialization (if needed)
0A	1. Initialize the first 32 interrupt vectors with corresponding Interrupt handlers Initialize INT no from 33-120 with Dummy(Suprious) Interrupt Handler 2. Issue CPUID instruction to identify CPU type 3. Early Power Management initialization (OEM specific)

**\* The following POST Codes are for all of Compress Version & Non-Compress Version**

POST (hex)	Description
0B	<ol style="list-style-type: none"> <li>1. Verify the RTC time is valid or not</li> <li>2. Detect bad battery</li> <li>3. Read CMOS data into BIOS stack area</li> <li>4. PnP initializations including (PnP BIOS only)                             <ul style="list-style-type: none"> <li>-Assign CSN to PnP ISA card</li> <li>-Create resource map from ESCD</li> </ul> </li> <li>5. Assign IO &amp; Memory for PCI devices (PCI BIOS only)</li> </ol>
0C	Initialization of the BIOS Data Area (40 : 00 – 40:FF)
0D	<ol style="list-style-type: none"> <li>1. Program some of the Chipset value according to Setup. (Early Setup Value Program)</li> <li>2. Measure CPU speed for display &amp; decide the system clock speed</li> <li>3. Video initialization including Monochrome, CGA, EGA/VGA. If no display device found, the speaker will beep which consists of one single long beep followed by two short beeps.</li> </ol>
0E	<ol style="list-style-type: none"> <li>1. Initialize the APIC (Multi-Processor BIOS only)</li> <li>2. Test video RAM (If Monochrome display device found)</li> <li>3. Show messages including:                             <ul style="list-style-type: none"> <li>-Award Logo, Copyright string, BIOS Date code &amp; Part No.</li> <li>-OEM specific sign on messages</li> <li>-Energy Star Logo (Green BIOS ONLY)</li> <li>-CPU brand, type &amp; speed</li> <li>-Test system BIOS checksum(Non-Compress Version only)</li> </ul> </li> </ol>
0F	DMA channel 0 test
10	DMA channel 1 test
11	DMA page registers test
12-13	Reserved
14	Test 8254 Timer 0 Counter 2.
15	Test 8259 interrupt mask bits for channel 1
16	Test 8259 interrupt mask bits for channel 2
17	Reserved
19	Test 8259 functionality
1A-1D	Reserved

1E	If EISA NVM checksum is good, execute EISA initialization (EISA BIOS only)
1F-29	Reserved
30	Detect Base Memory & Extended Memory Size
31	1. Test Base Memory from 256K to 640K 2. Test Extended Memory from 1M to the top of memory
32	1. Display the Award Plug & Play BIOS Extension message (PnP BIOS only) 2. Program all onboard super I/O chips (if any) including COM ports, LPT ports, FDD port... according to setup value
33-3B	Reserved
3C	Set flag to allow users to enter CMOS Setup Utility
3D	1. Initialize Keyboard 2. Install PS2 mouse

POST(hex)	Description
3E	Try to turn on Level 2 cache Note: Some chipset may need to turn on the L2 cache in this stage. But usually, the cache is turn on later in POST 61h
3E	Try to turn on Level 2 cache Note: Some chipset may need to turn on the L2 cache in this stage. But usually, the cache is turn on later in POST 61h
BF	1. Program the rest of the Chipset value according to Setup. (Later Setup Value Program) 2. If auto-configuration is enabled, programmed the chipset with pre-defined values in the MODBINable Auto-Table
41	Initialize floppy disk drive controller
42	Initialize Hard drive controller
43	If it is a PnP BIOS, initialize serial & parallel ports
44	Reserved
45	Initialize math coprocessor.
46-4D	Reserved
4E	If there is any error detected (such as video, kb...), show all the error messages on the screen & wait for user to press <F1> key
4F	1. If password is needed, ask for password 2. Clear the Energy Star Logo (Green BIOS only)
50	Write all CMOS values currently in the BIOS stack area back into the CMOS
51	Reserved
52	1. Initialize all ISA ROMs 2. Later PCI initializations (PCI BIOS only) -assign IRQ to PCI devices -initialize all PCI ROMs 3. PnP Initializations (PnP BIOS only) -assign IO, Memory, IRQ & DMA to PnP ISA devices -initialize all PnP ISA ROMs 4. Program shadows RAM according to Setup settings 5. Program parity according to Setup setting 6. Power Management Initialization -Enable/Disable global PM -APM interface initialization

53	1. If it is NOT a PnP BIOS, initialize serial & parallel ports 2. Initialize time value in BIOS data area by translate the RTC time value into a timer tick value
60	Setup Virus Protection (Boot Sector Protection) functionality according to Setup settin

***BIOS Default Drive Table***

This is a current list of the drive type table contained in Setup.

Type	Size (MB)	Cylinders	Heads	Sectors	Write Precomp	Land Zone	Example Model
1	10	306	4	17	128	305	TEAC SD510, MMI 112, 5412
2	20	615	4	17	300	615	Seagate ST225, ST4026
3	30	615	6	17	300	615	
4	62	940	8	17	512	940	
5	46	940	6	17	512	940	
6	20	615	4	17	None	615	Seagate ST125, Tandon TM262
7	30	462	8	17	256	511	
8	30	733	5	17	None	733	Tandon TM 703
9	112	900	15	17	None	901	
10	20	820	3	17	None	820	
11	35	855	5	17	None	855	
12	49	855	7	17	None	855	
13	20	306	8	17	128	319	Disctron 526, MMI M125
14	42	733	7	17	None	733	
15		Reserved					

16	20	612	4	17	0	663	Microscience HH725, Syquest 3250, 3425
17	40	977	5	17	300	977	
18	56	977	7	17	None	977	
19	59	1024	7	17	512	1023	
20	30	733	5	17	300	732	
21	42	733	7	17	300	732	
22	30	306	5	17	300	733	Seagate ST4038
23	10	977	4	17	0	336	

24	40	1024	5	17	None	976	Seagate ST4051
25	76	1224	9	17	None	1023	Seagate ST4096
26	71	1224	7	17	None	1223	Maxtor 2085
27	111	1224	11	17	None	1223	Maxtor 2140, Priam S14
28	152	1024	15	17	None	1223	Maxtor 2190, Priam S19
29	68	1024	8	17	None	1023	Maxtor 1085, Micropolis 1325
30	93	918	11	17	None	1023	Maxtor 1105 1120, 4780
31	83	925	11	17	None	1023	Maxtor 1170
32	69	1024	9	17	None	926	CDC 9415
33	85	1024	10	17	None	1023	
34	102	1024	12	17	None	1023	
35	110	1024	13	17	None	1023	
36	119	1024	14	17	None	1023	
37	17	1024	2	17	None	1023	
38	136	1024	16	17	None	1023	
39	114	918	15	17	None	1023	Maxtor 1140, 4380
40	40	820	6	17	None	820	Seagate ST251
41	42	1024	5	17	None	1023	Seagate 4053 Miniscribe 3053/6053
42	65	1024	5	26	None	1023	Miniscribe 3053/6053 RLL
43	40	809	6	17	None	852	Miniscribe 3650
44	61	809	6	26	None	852	Miniscribe 3675 RLL
45	100	776	8	33	None	775	Conner CP3104
46	203	684	16	38	None	685	Conner CP3204
User							



## Chapter 5

# VGA Driver Installation Procedures

### 5.1 Windows 95/98 Drivers Setup Procedure

1. In the "Control Panel" screen, select the "Display" icon and click "Display Type".



Figure 5-1: Opening the Windows Control Panel

2. When installing Windows 95/98, choose the "Settings" icon.

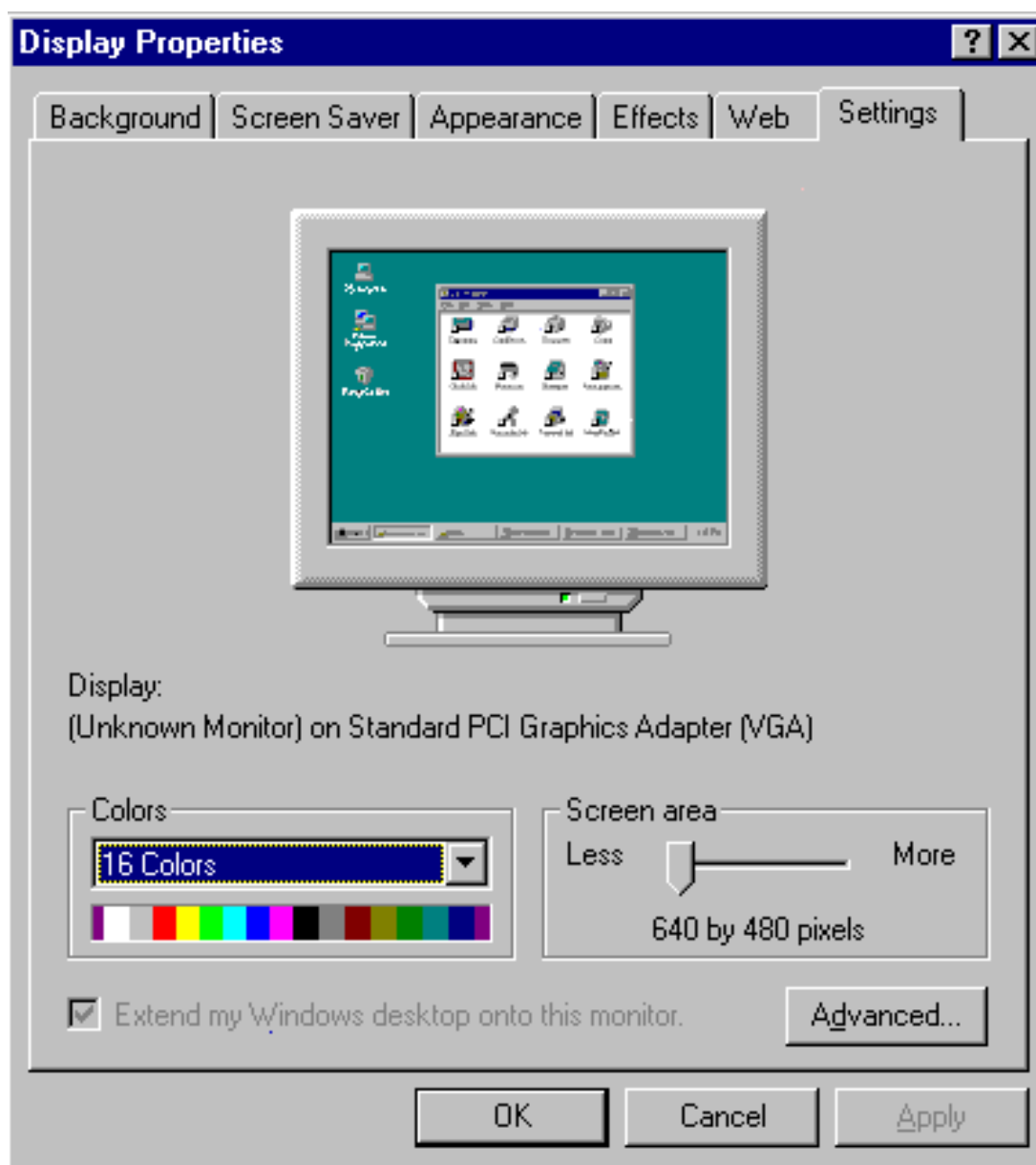

Figure 5-2: Open "Display Type" from the Windows Control Panel

3. Click "Change".

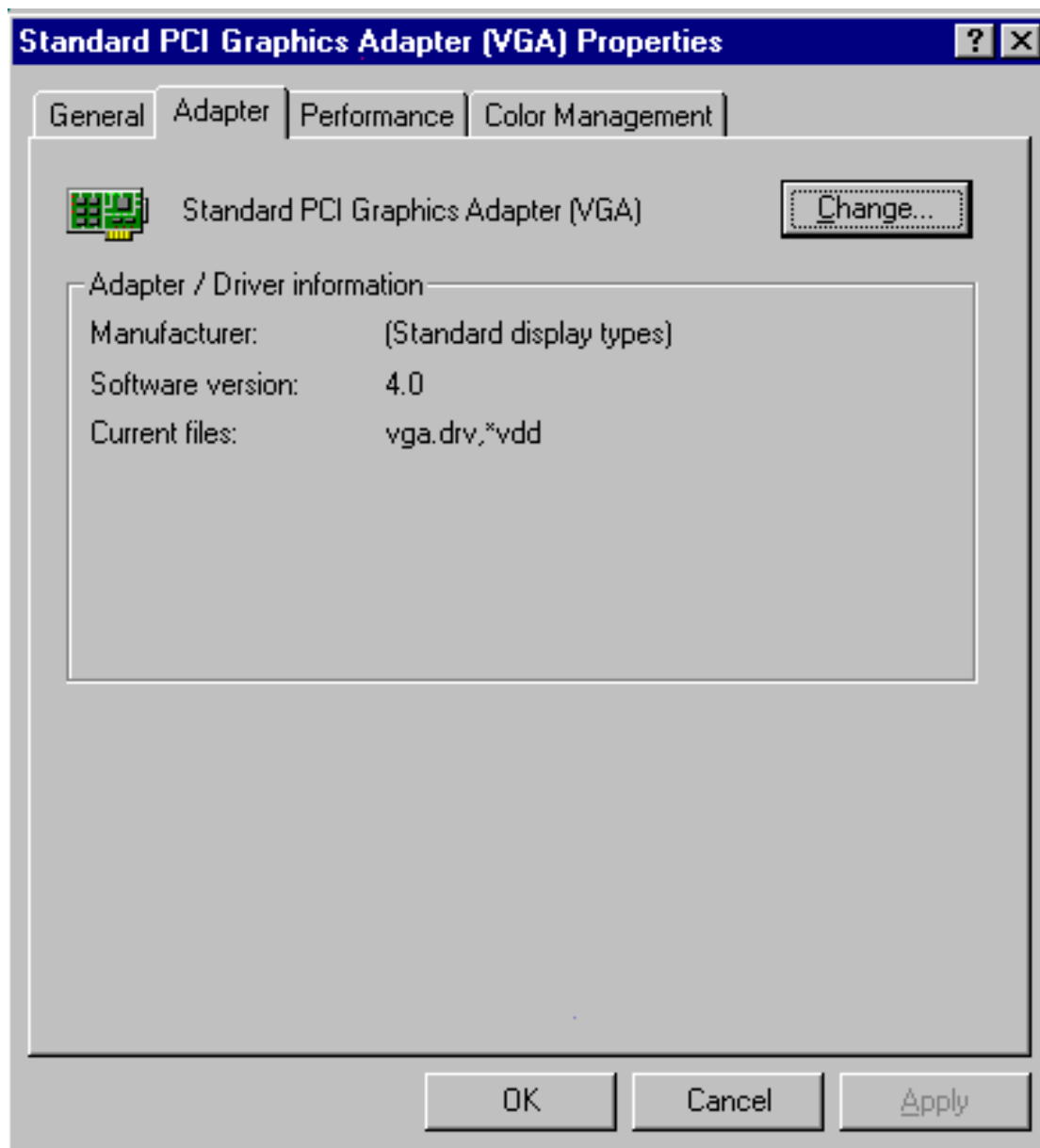

Figure 5-3: Clicking the "Change" button within "Display Type".

4. Click "Next".



Figure 5-4: Clicking the "Next" button

5. Select "Display a list of all the drivers in a specific location, so you can select the driver you want."



Figure 5-5: Choosing Display adapters from the Hardware types list

6. Click "Have Disk".

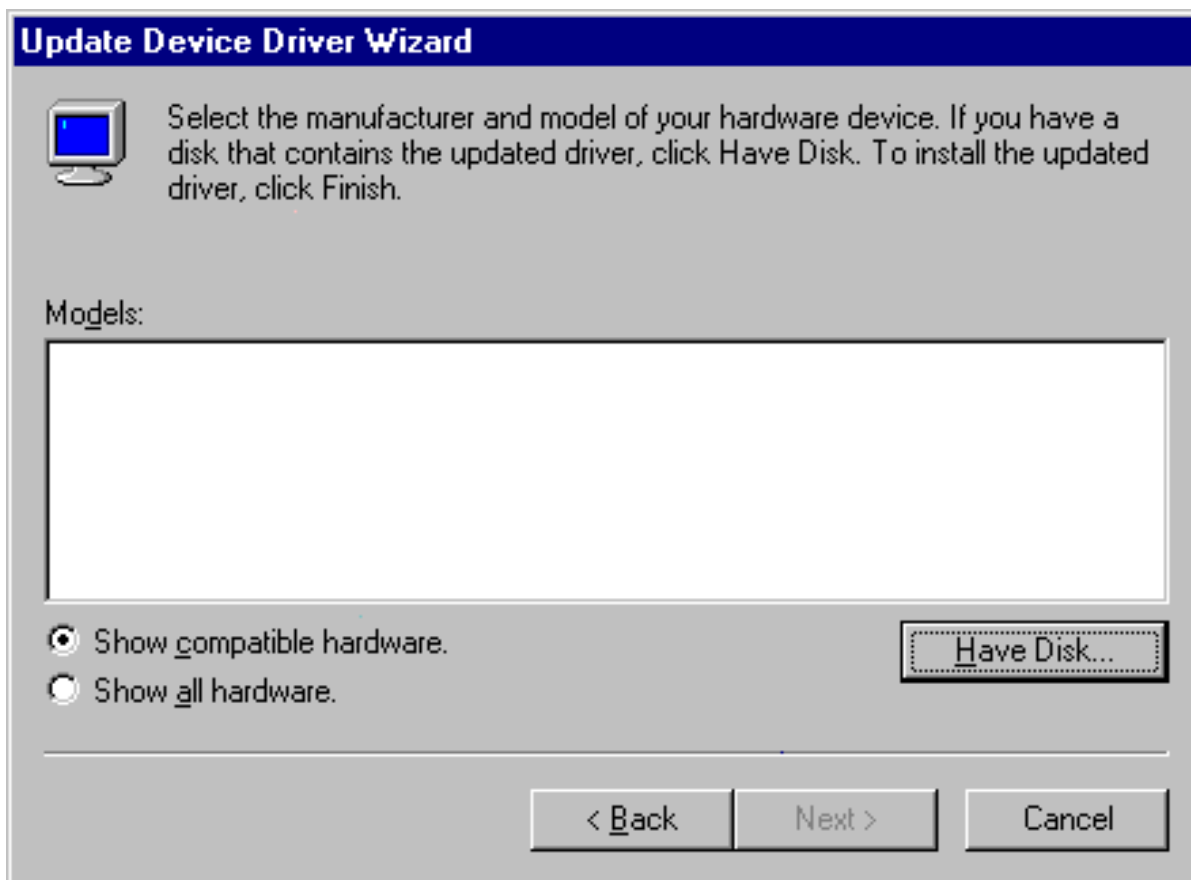

Figure 5-6: Selecting "Have Disk" button.

7. Click on "Browse..." to look for the driver program.

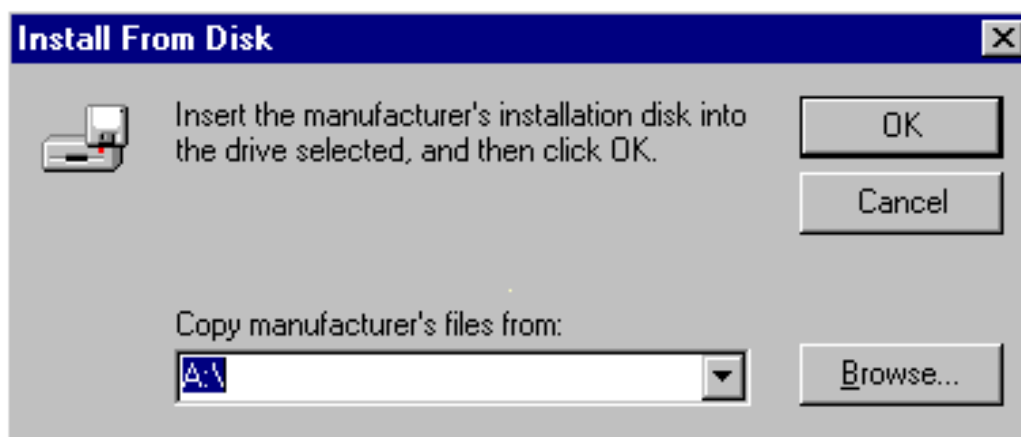

Figure 5-7: Clicking on the "Browse" button

8. Select "chips95.inf" in the open window, and click on **K**

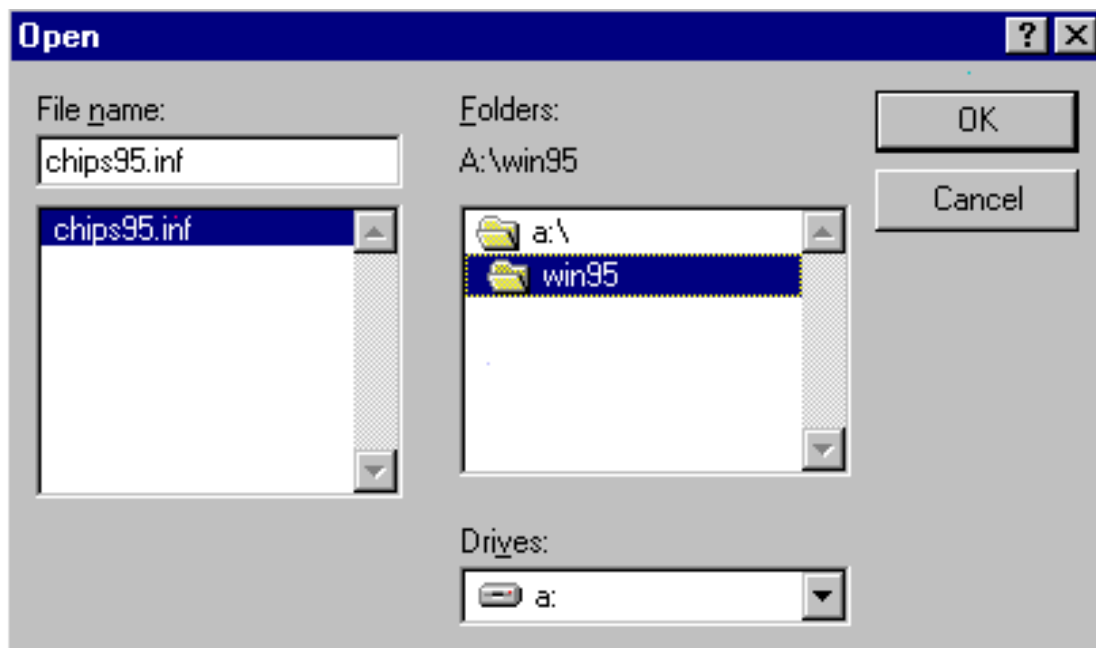

Figure 5-8: Selecting "chips98.inf"

9. Select "Chips and Tech. 69000 PCI" and click on "OK".

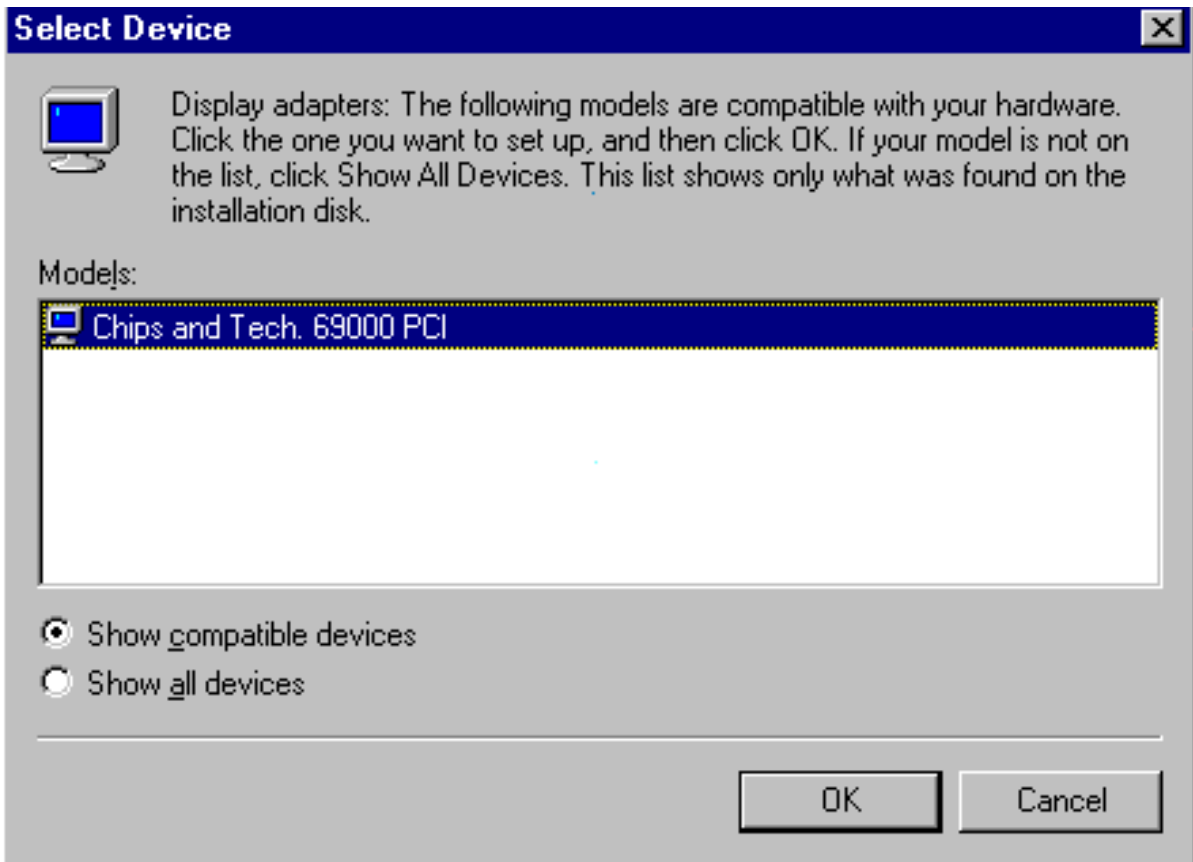

Figure 5-9: Selecting Chips and Tech. 69000 PCI

10. Click on "Next" to start copying the driver.



Figure 5-10: Clicking on the Next button

11. Click on "Finish" to complete the setup procedure.



Figure 5-11: Clicking on "Finish"

## 5.2 Windows NT Drivers Setup Procedure

1. In the "Control Panel" screen, select the "Display" icon.

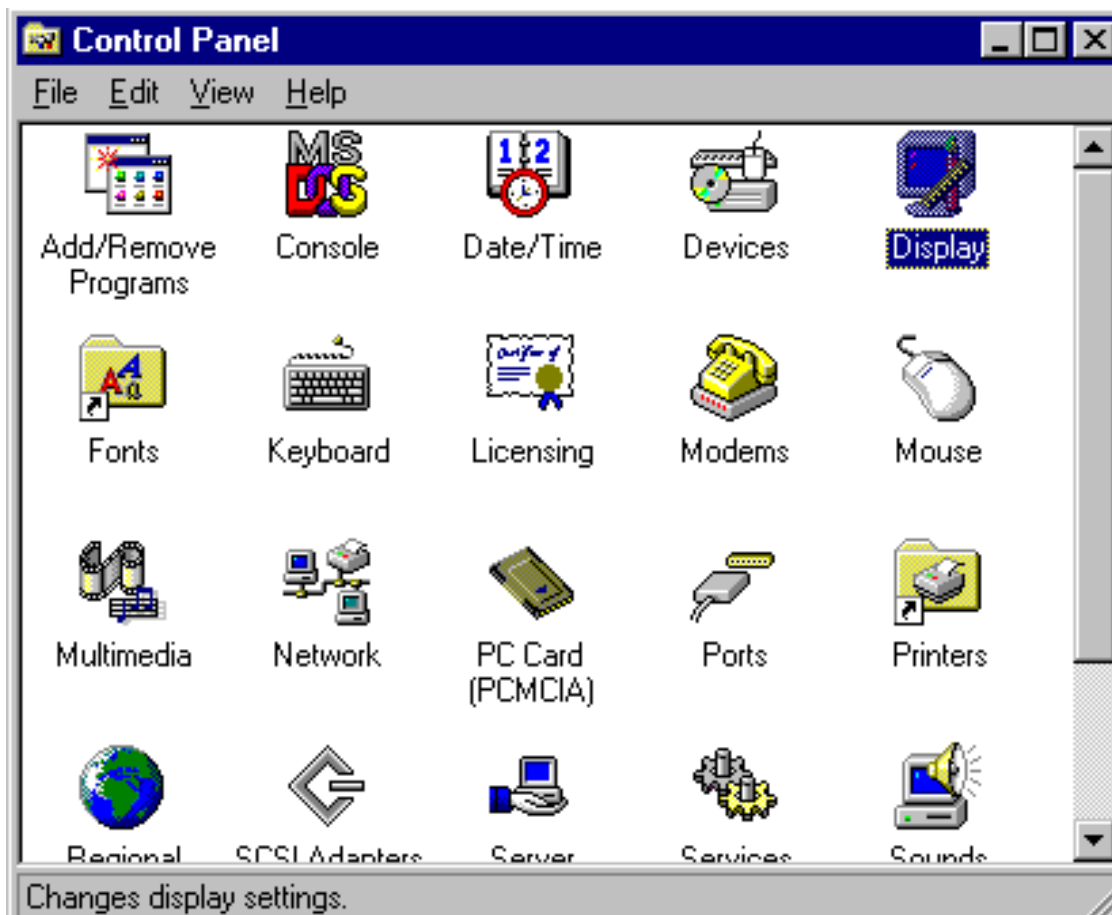

Figure 5-12: Clicking on Display Type in the Settings tab

2. In the Display Properties window, select the Settings tab and click on "Display Type".

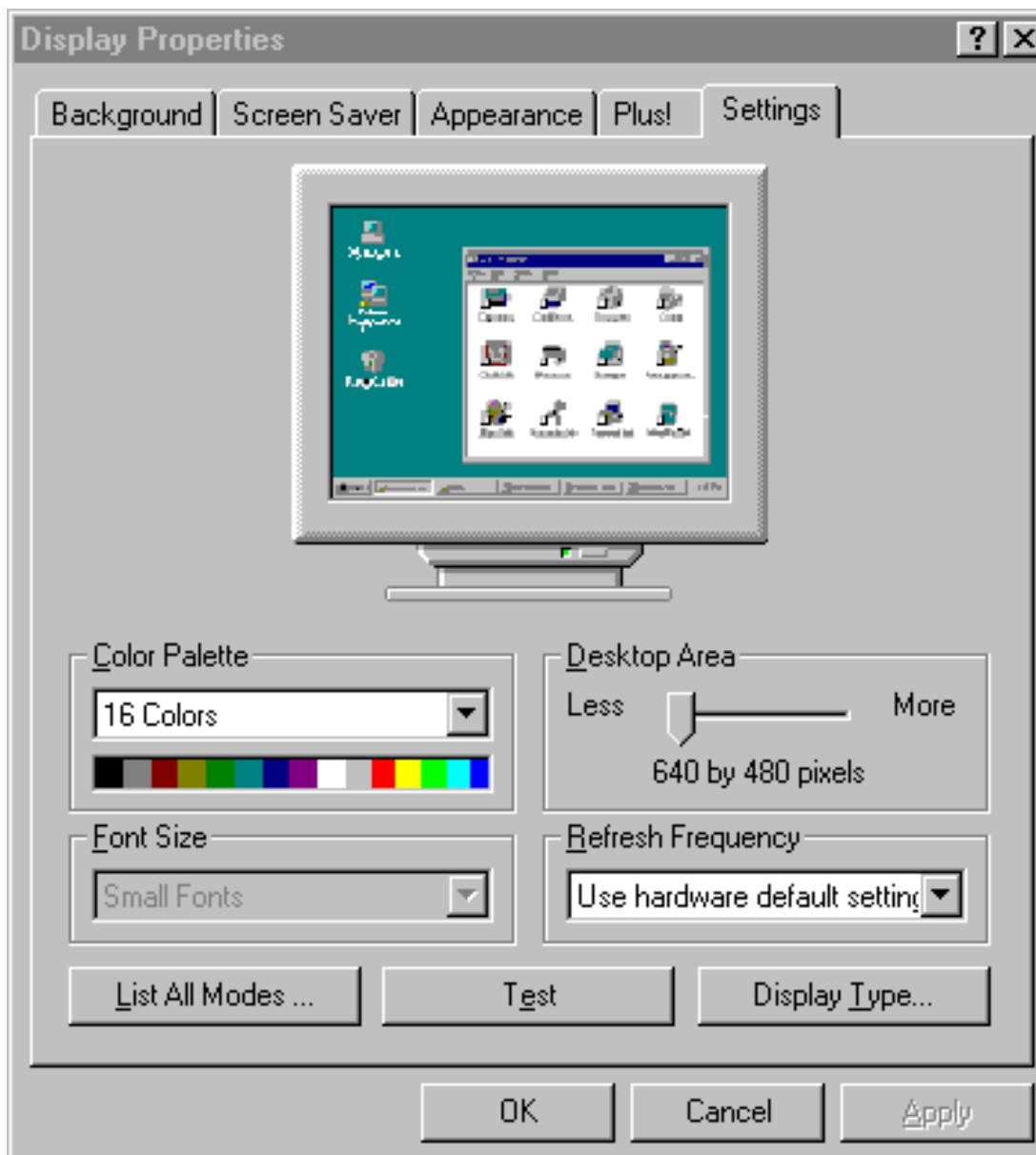

Figure 5-13: Choosing Setting tab and clicking Display Type button

3. Click on "Change..." in the Display Type window.

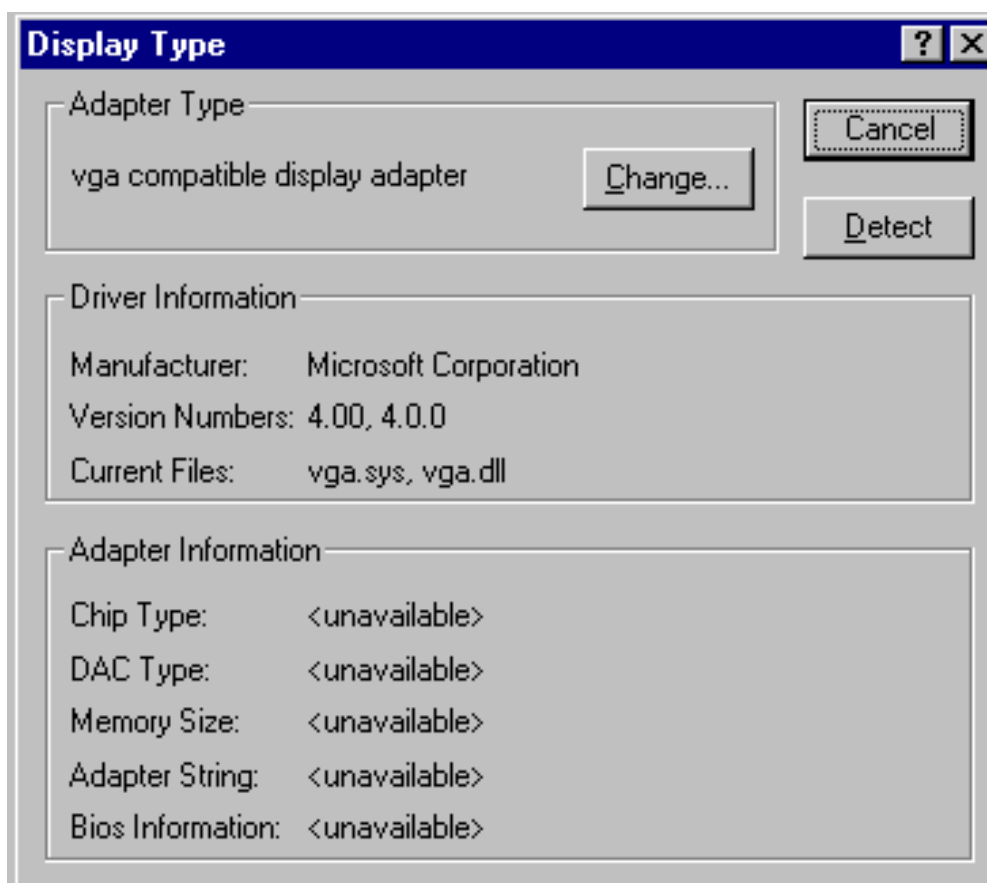

Figure 5-14: Clicking on the Change button

4. Click on "Have Disk..." in the Change Display window.

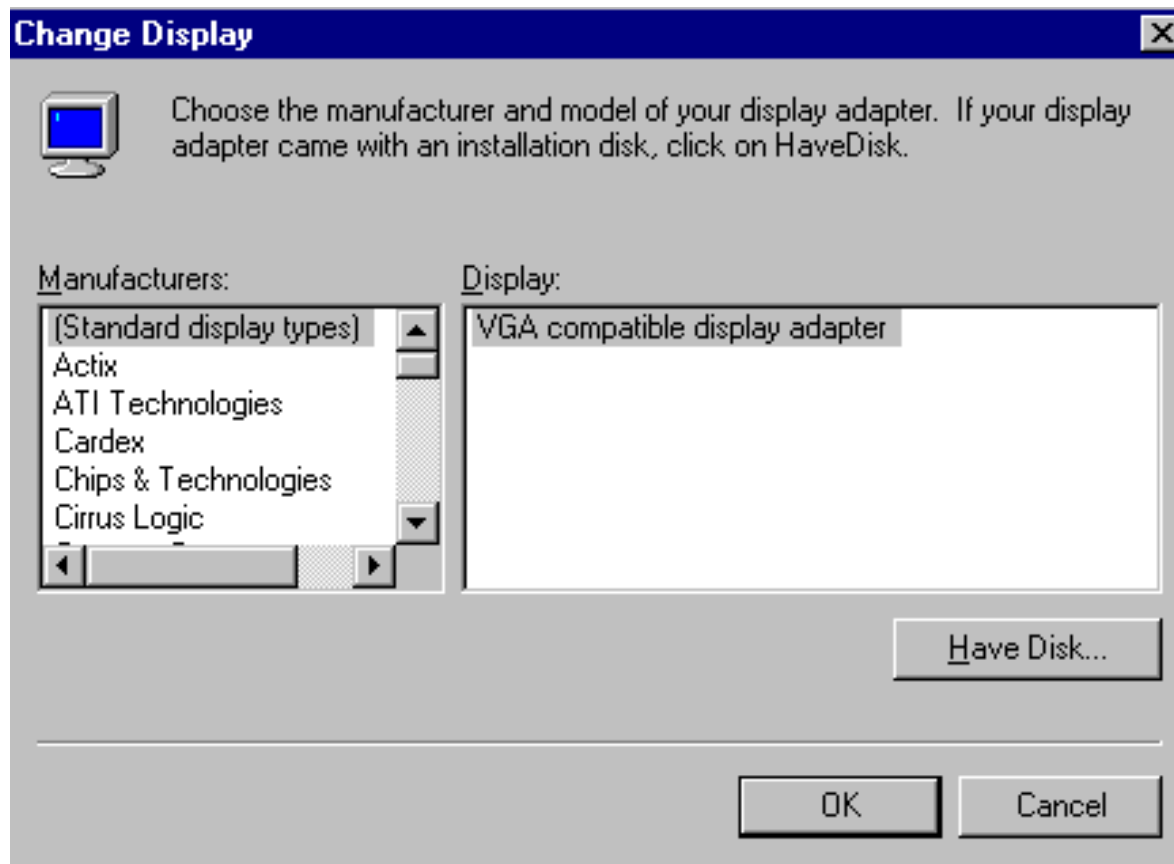

Figure 5-15: Clicking on the Have Disk button

5. Click on "Browse..." to look for the driver program.

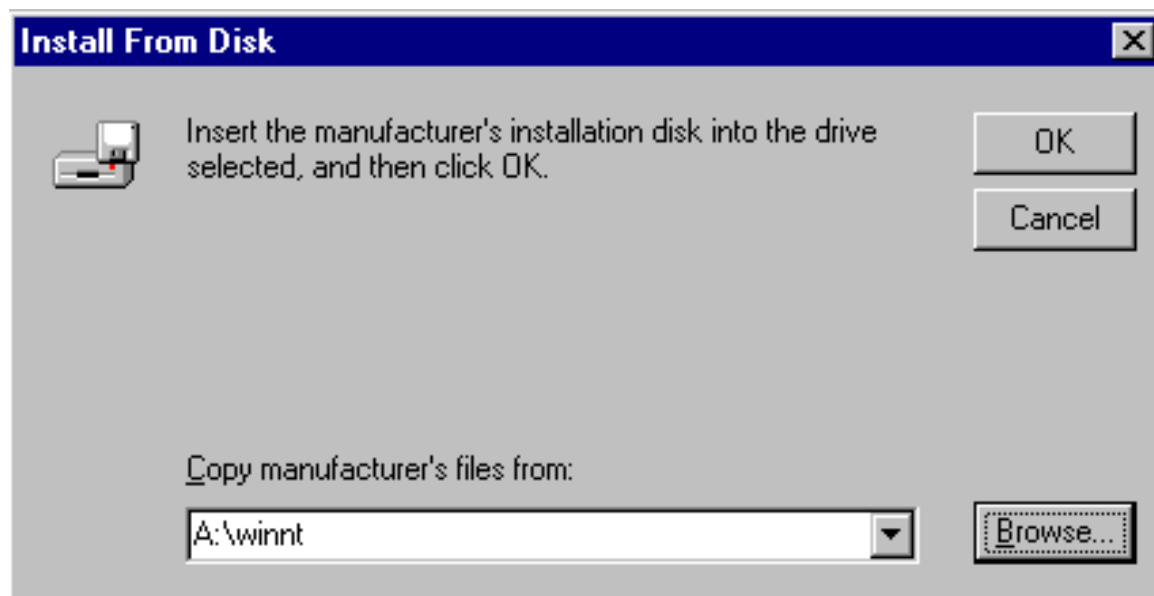

Figure 5-16: Clicking Browse button

6. Click on "OK" and then the driver has been successfully installed.

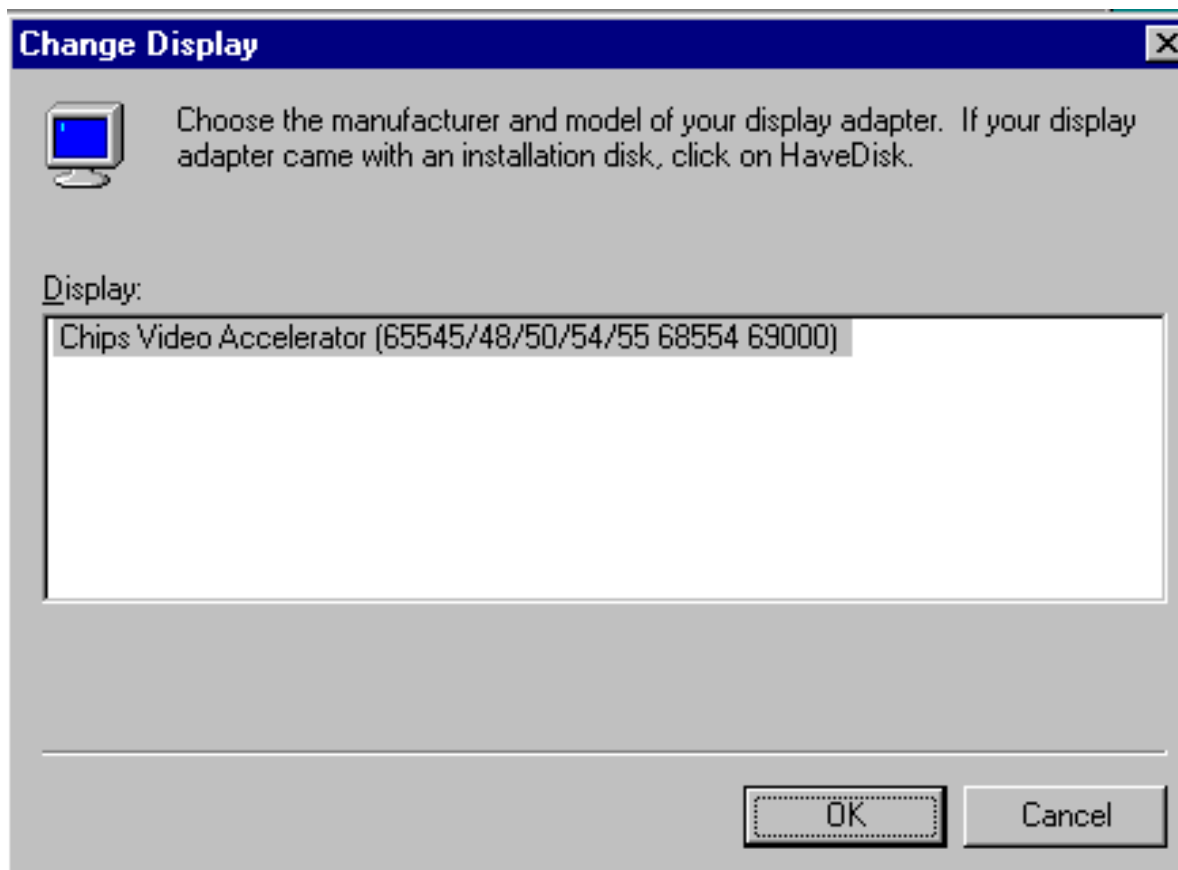

Figure 5-17: Clicking on the OK button

## Chapter 6

# LAN Driver Installation Procedures

### 6.1 Windows 95/98 Drivers Setup Procedure

1. In the "Control Panel" screen, click "Add New Hardware".



Figure 6-1: Opening "Control Panel" and selecting "Add New Hardware" icon.

2. Click on "Next" button



Figure 6-2: Starting the Add New Hardware wizard

3. Choose "Search for the best driver for your device. (Recommended)" and then click on "Next".

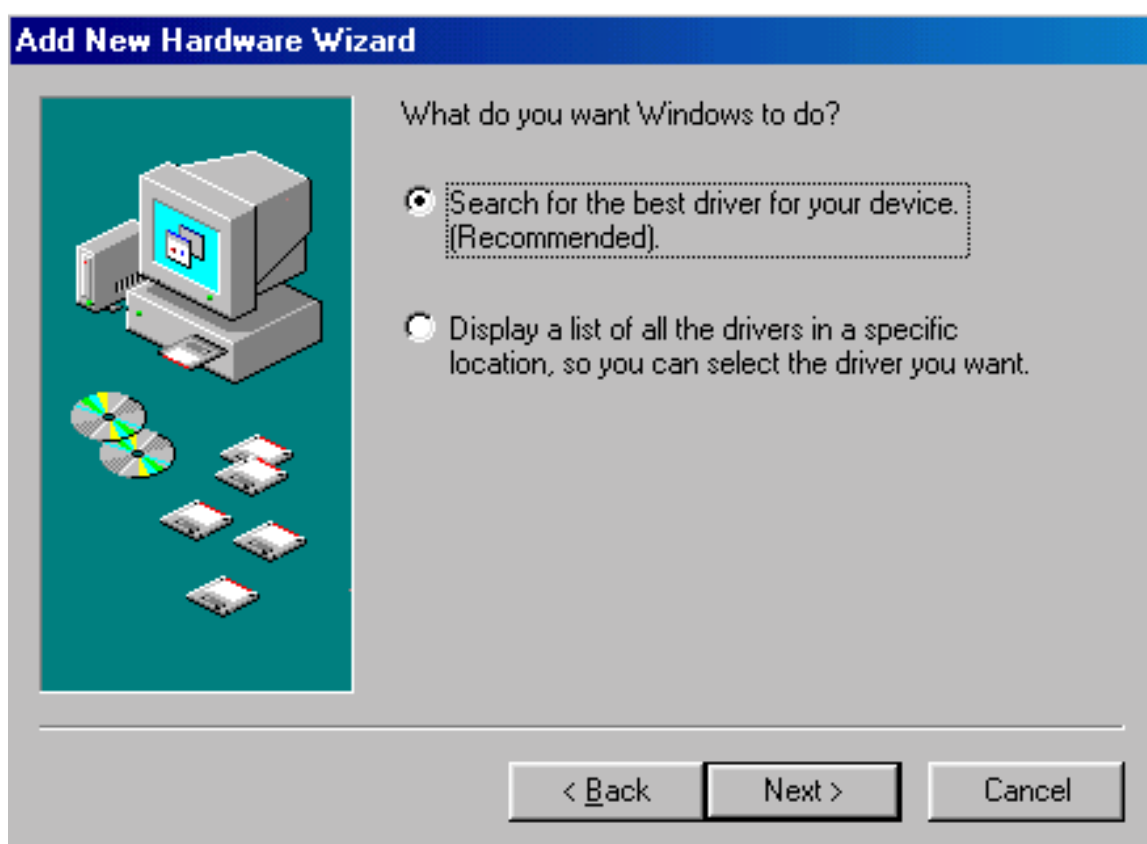

Figure 6-3: Clicking on the "Next" button

4. Choose "Floppy disk drives" and click on "Next".



Figure 6-4: Selecting the device from the list and then click on "Next".

5. Click on "Next" and the driver will be installed.

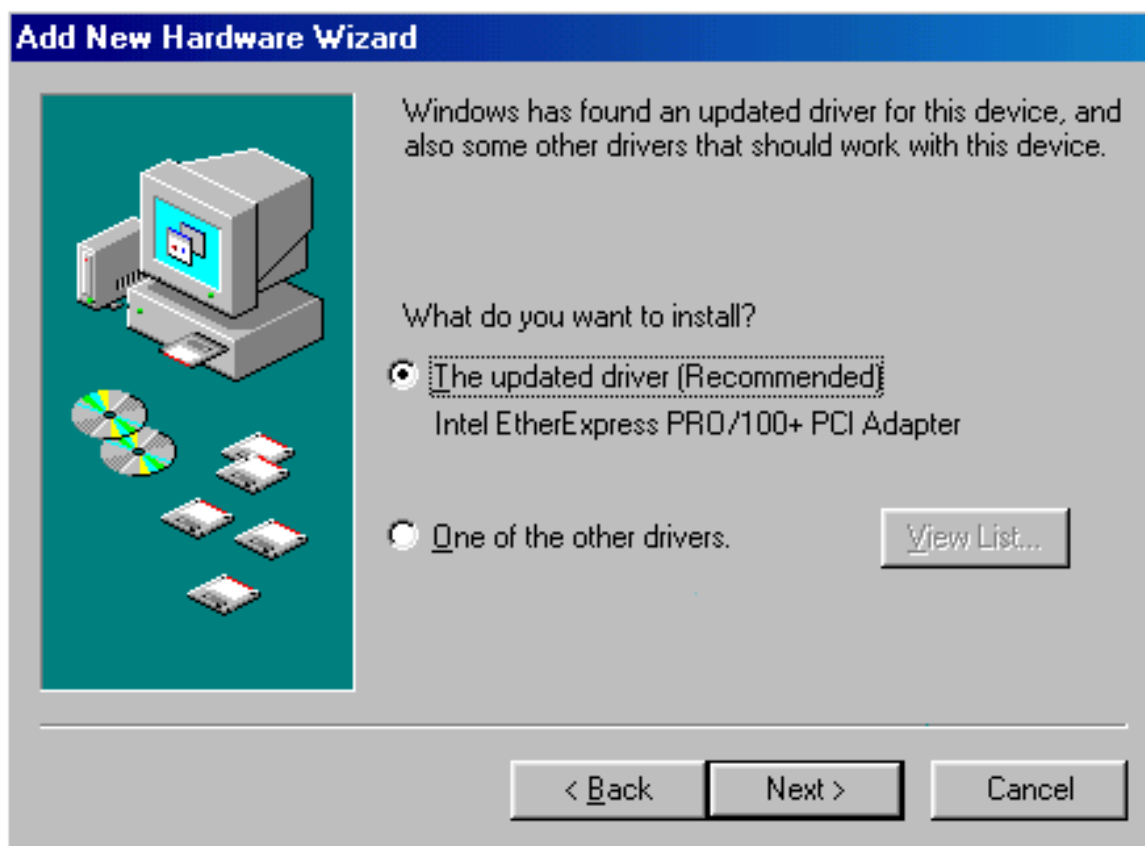

Figure 6-5: Clicking on "Next" button and the driver will be installed.

## 6.2 Windows NT Drivers Setup Procedure

1. In the "Windows NT" screen, click "Start" and select "Settings". Then click on the "Control Panel" icon.

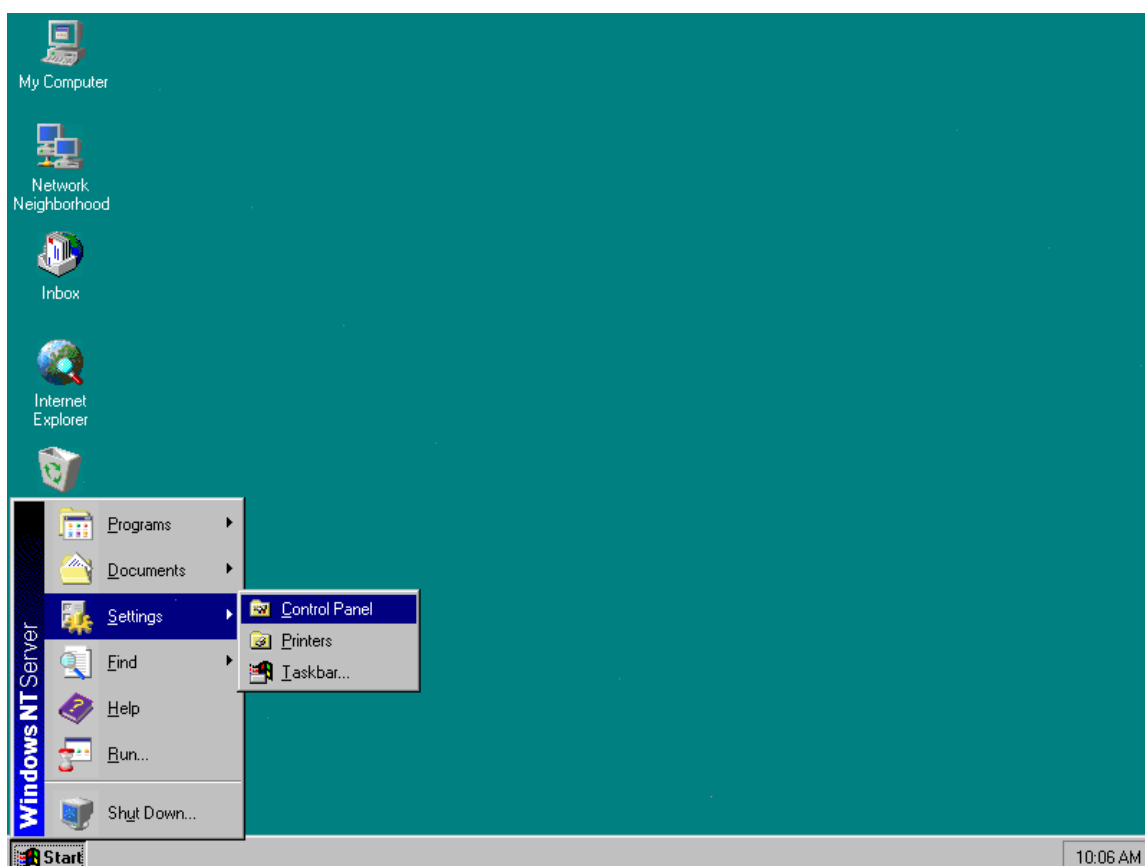

Figure 6-12: Open the "Control Panel" window

2. In the "Control Panel" window, click "Network" icon.

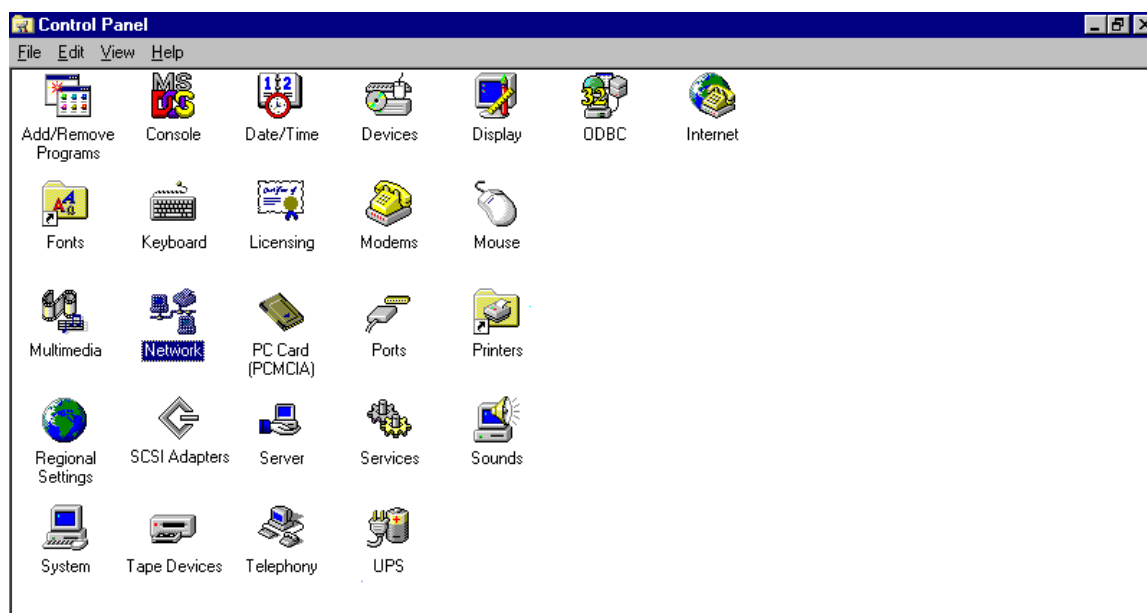

Figure 6-13: Double-clicking on the Network icon in the Control Panel

3. In the “Network” window, select the “Adapters” tab. Click on “Add...” to add your new driver.

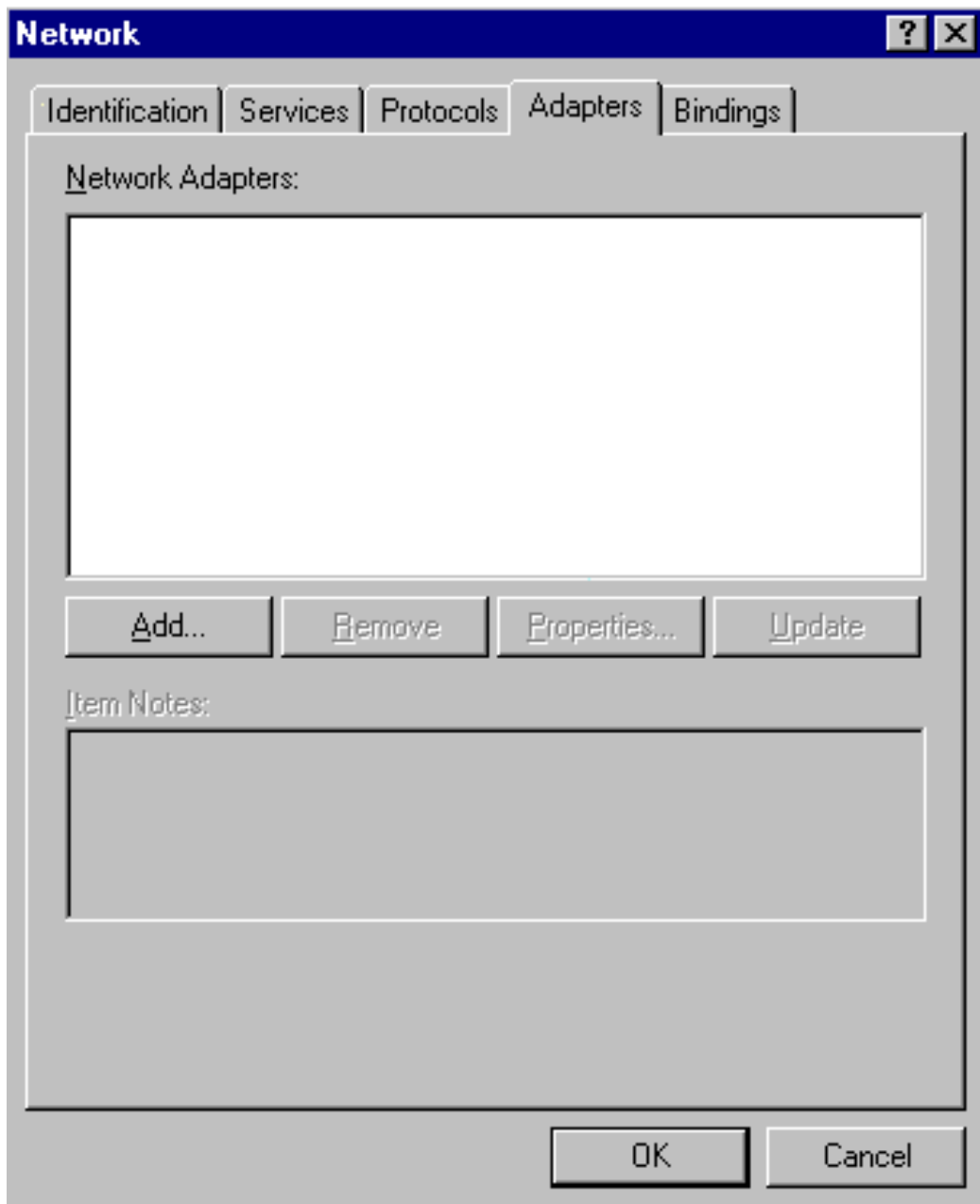

Figure 6-14: Clicking on the Add button

4. Select "Have Disk..." to find the Network Adapters Driver program.

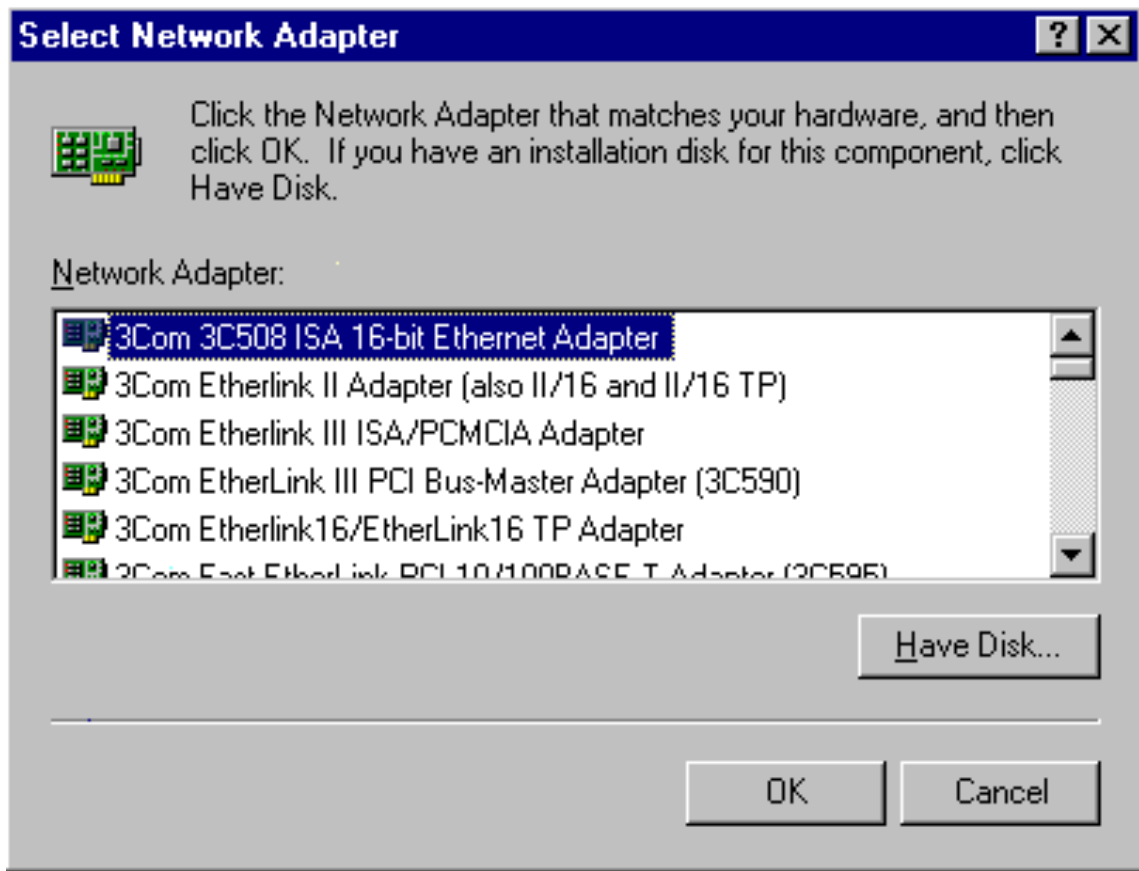

Figure 6-15: Clicking on Have Disk

5. Click on "OK".

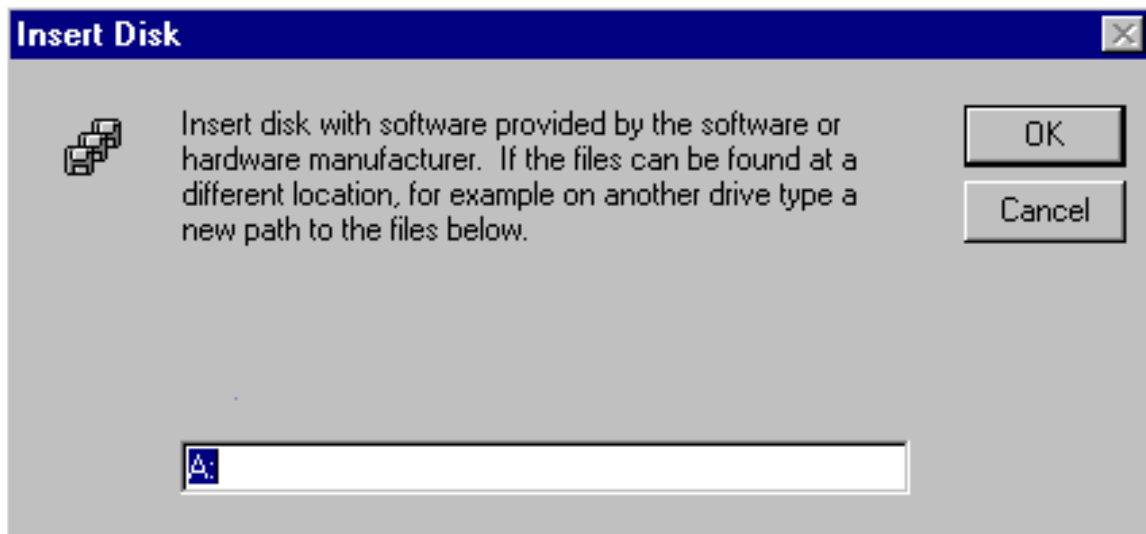

Figure 6-16: Clicking on the OK button

6. Click on "OK" and the driver will be installed.

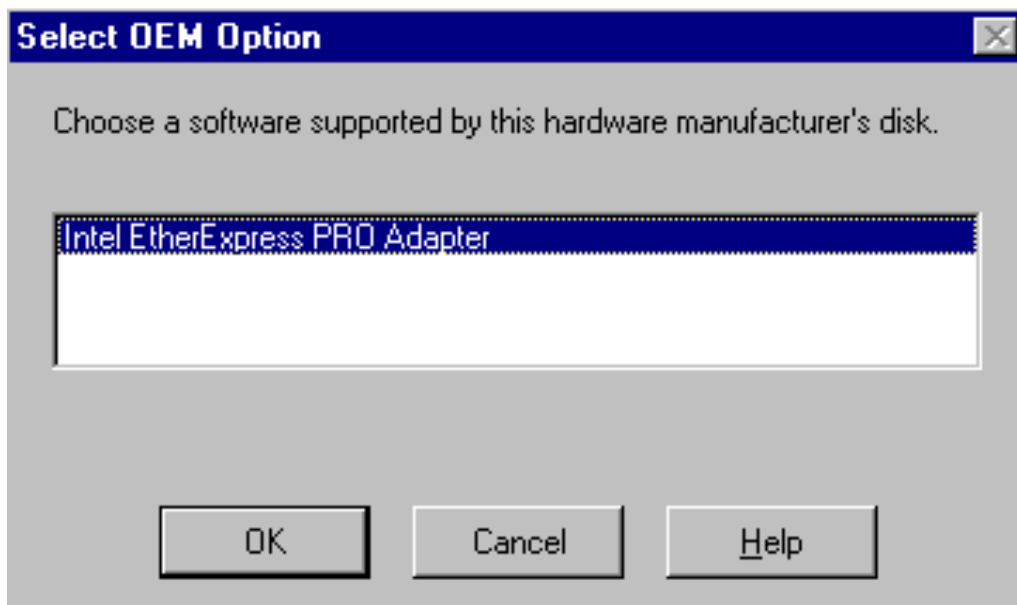

Figure 6-17: Clicking on the OK button

## Chapter 7

# SCSI Driver Installation Procedures

## 7.1 Windows 95/98 Drivers Setup Procedure

1. In the "Control Panel" screen, select the "System" icon and click "Display Type".

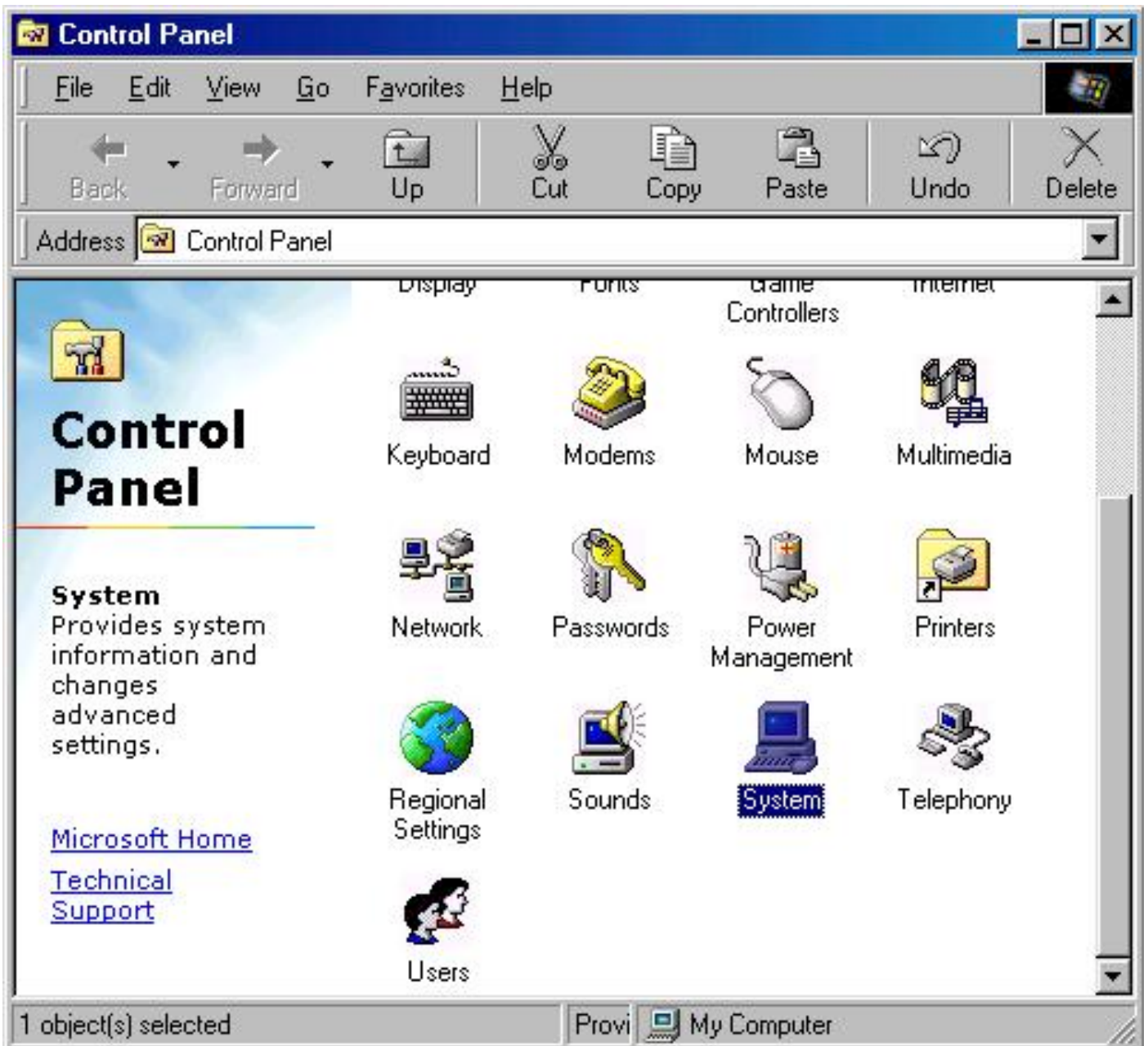

Figure 7-1: Opening the Windows Control Panel

2. Click on "OK" button.

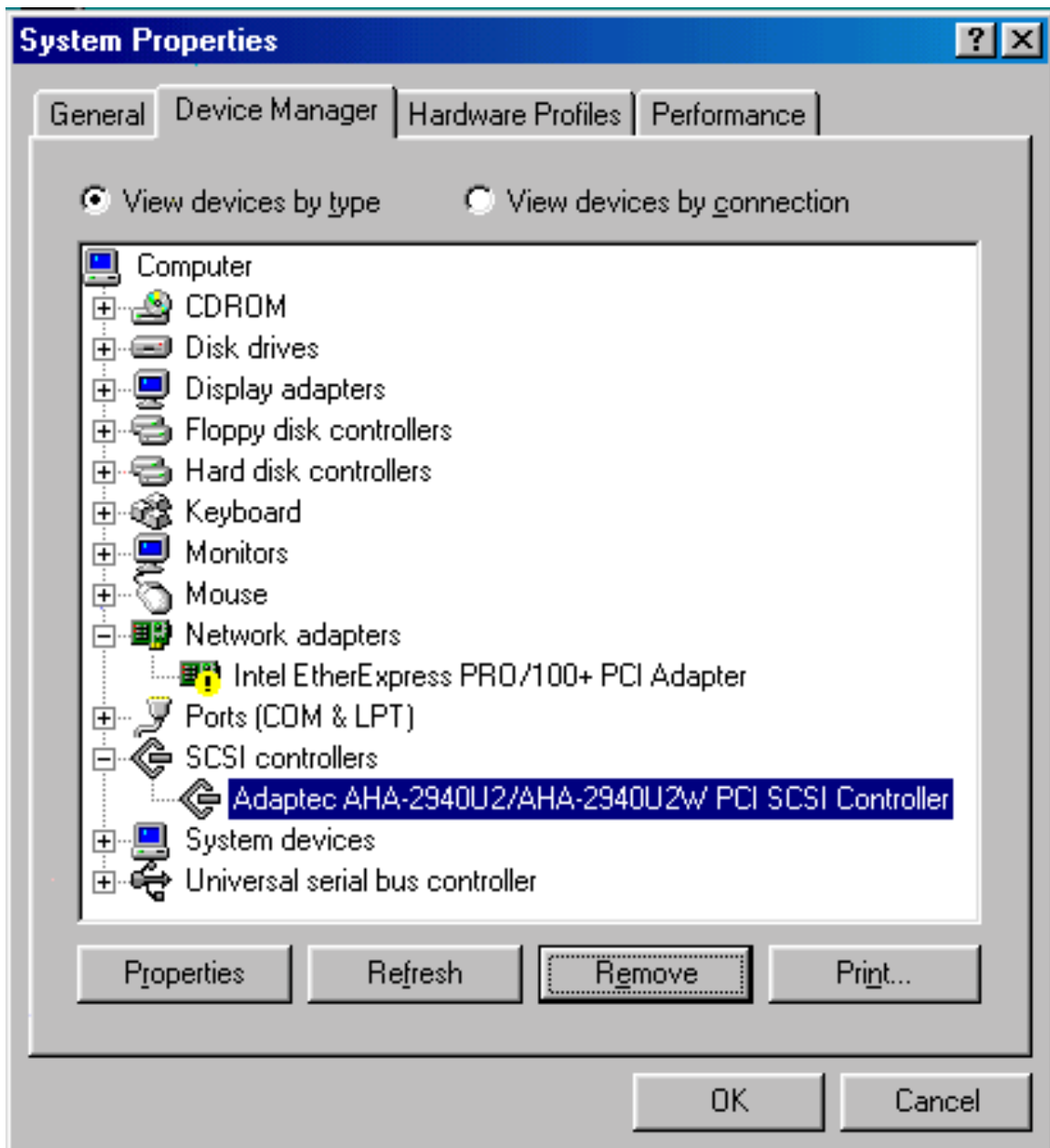

Figure 7-2: Clicking on "Ok" button.

3. Choose the "Update Driver" icon.



Figure 7-3: Clicking the "Update Driver" button.

4. Click "Next".

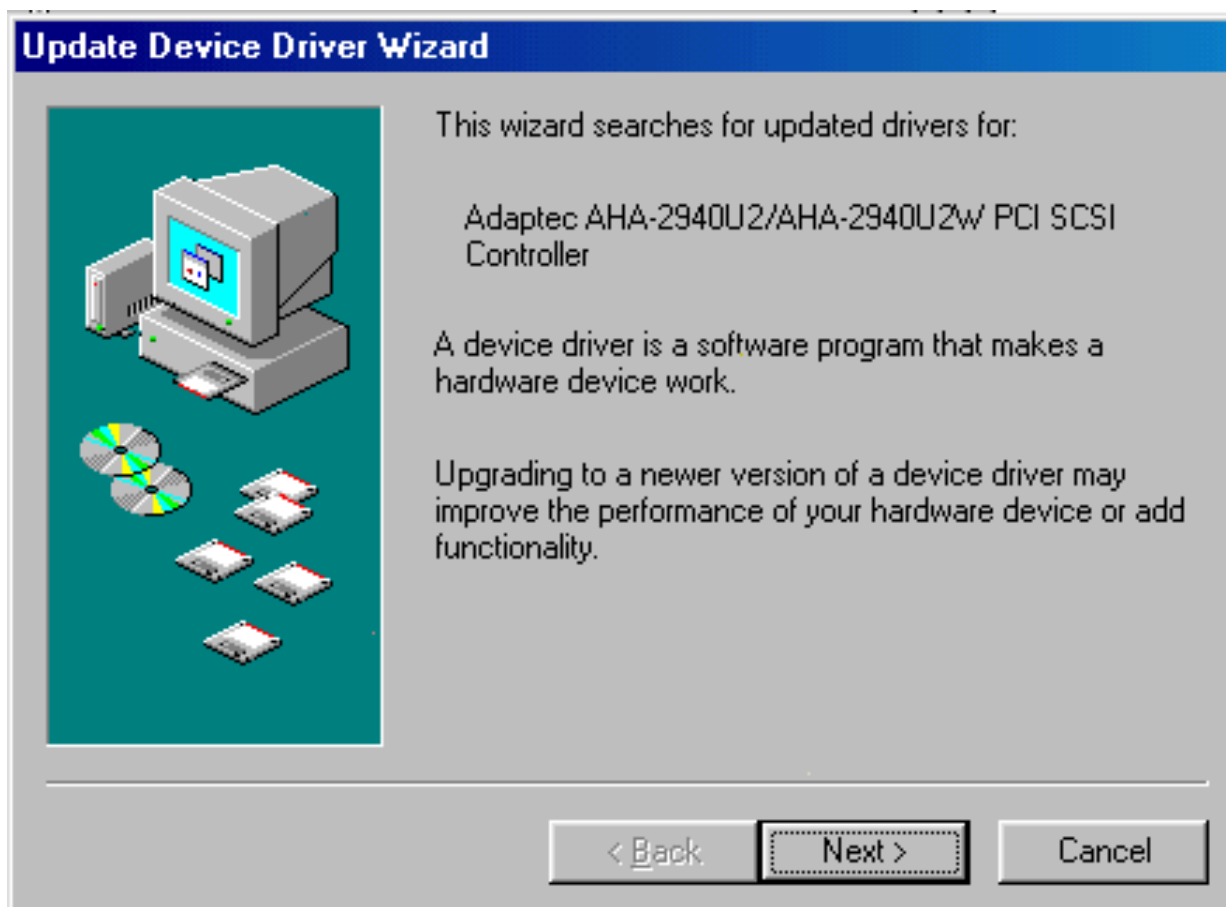

Figure 5-4: Clicking the "Next" button

5. Click "Next".

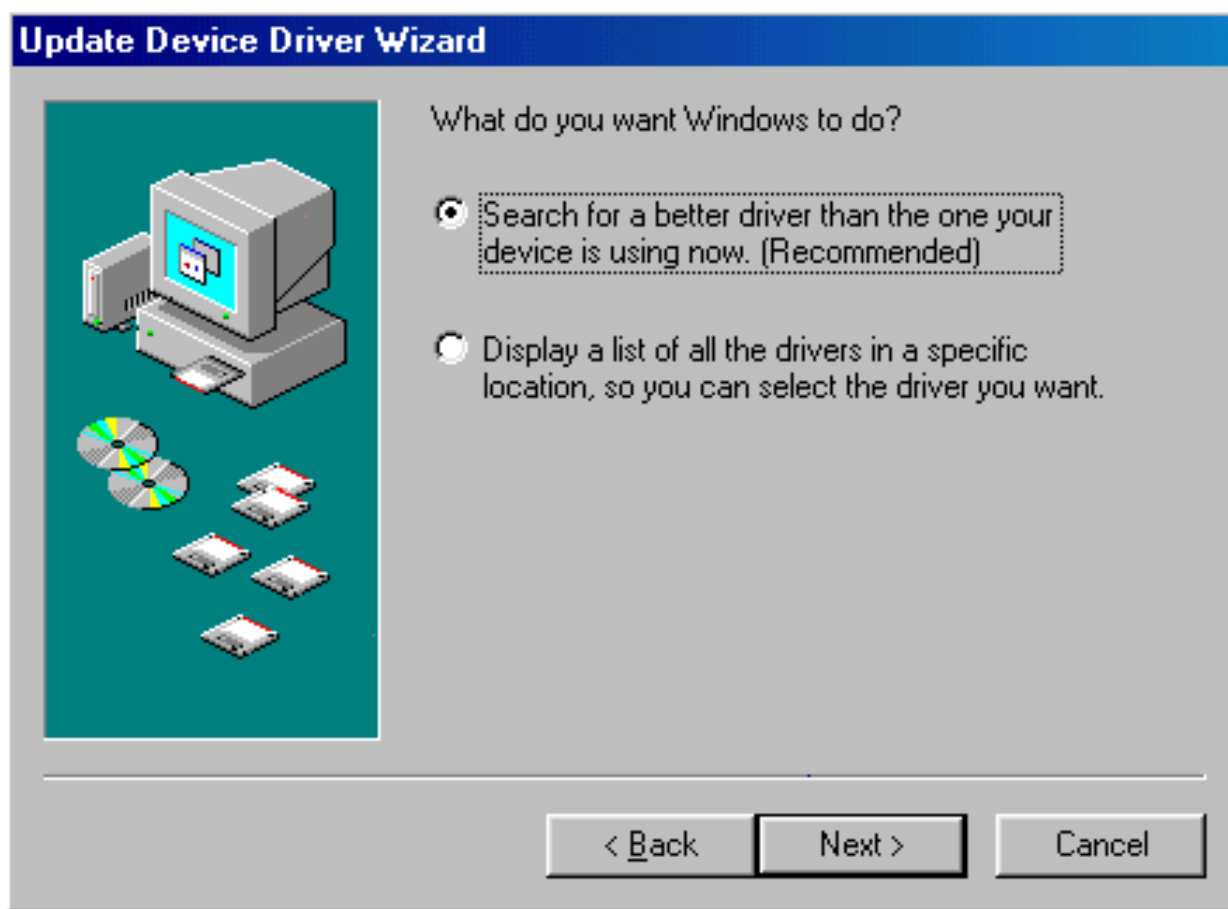

Figure 7-5: Clicking on "Next" button.

- Click "Floppy disk drives" and then click Next to start the search.



Figure 7-6: Selecting "Floppy disk drives" and clicking "Next" button.

7. Choosing the "Install one of the other drivers." and then click "View List".



Figure 7-7: Clicking on the "View list" button.

8. Click on **K**

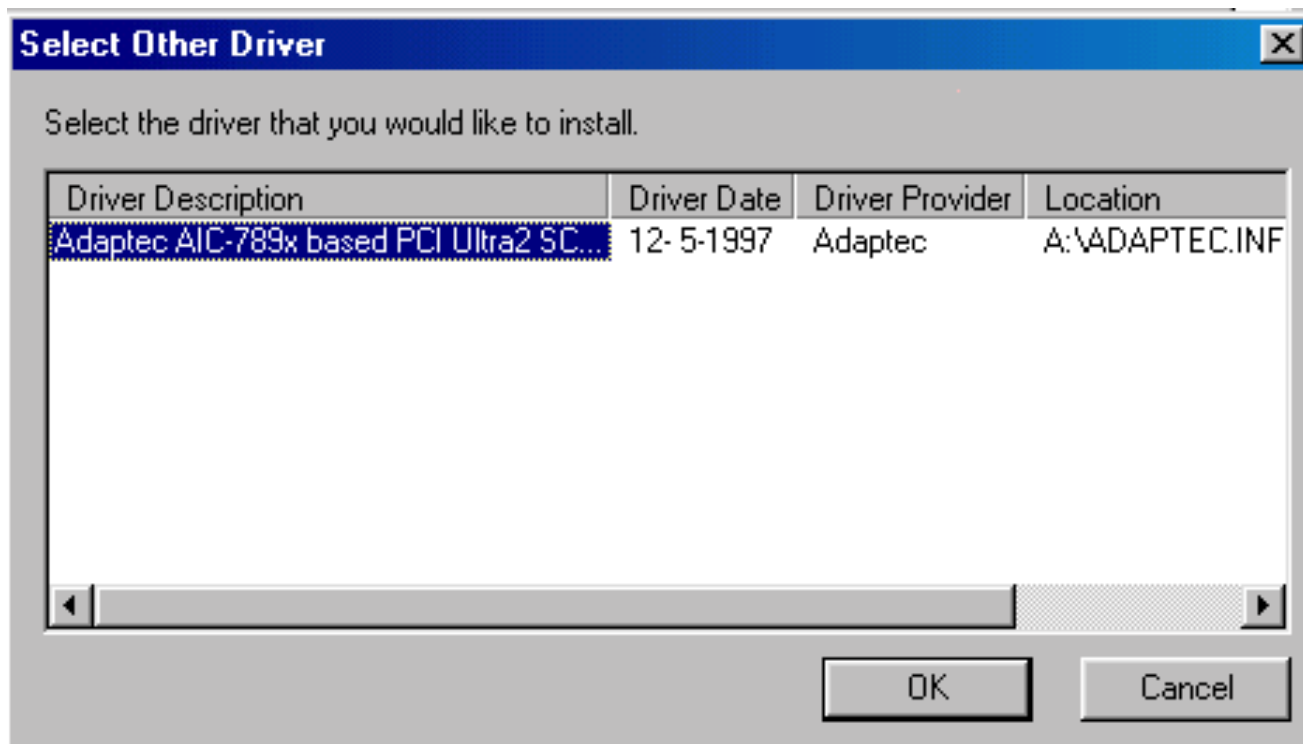

Figure 7-8: Clicking the "OK" button.

9. Click "Next".

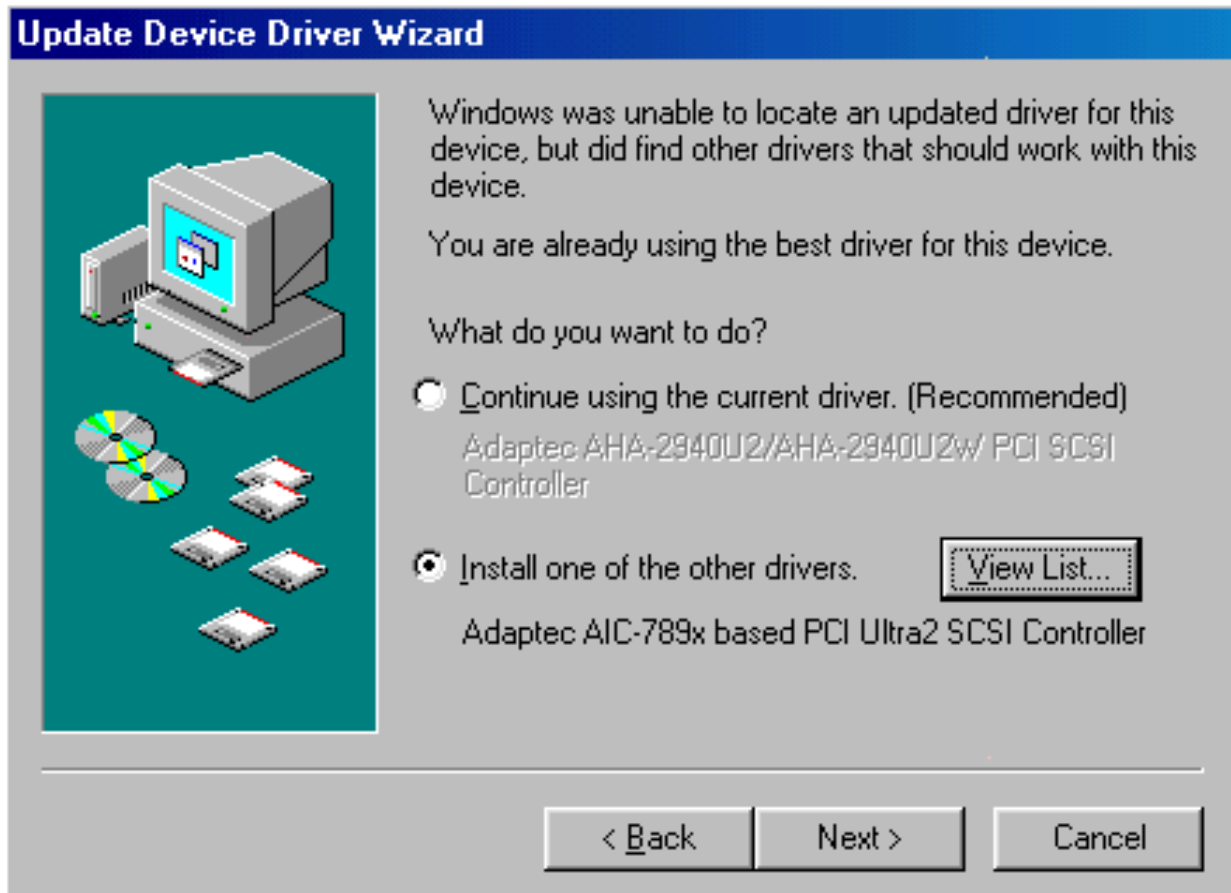

Figure 7-9: Clicking the "Next" button.

10. Click on "Next" to start copying the driver and then complete the setup procedure.

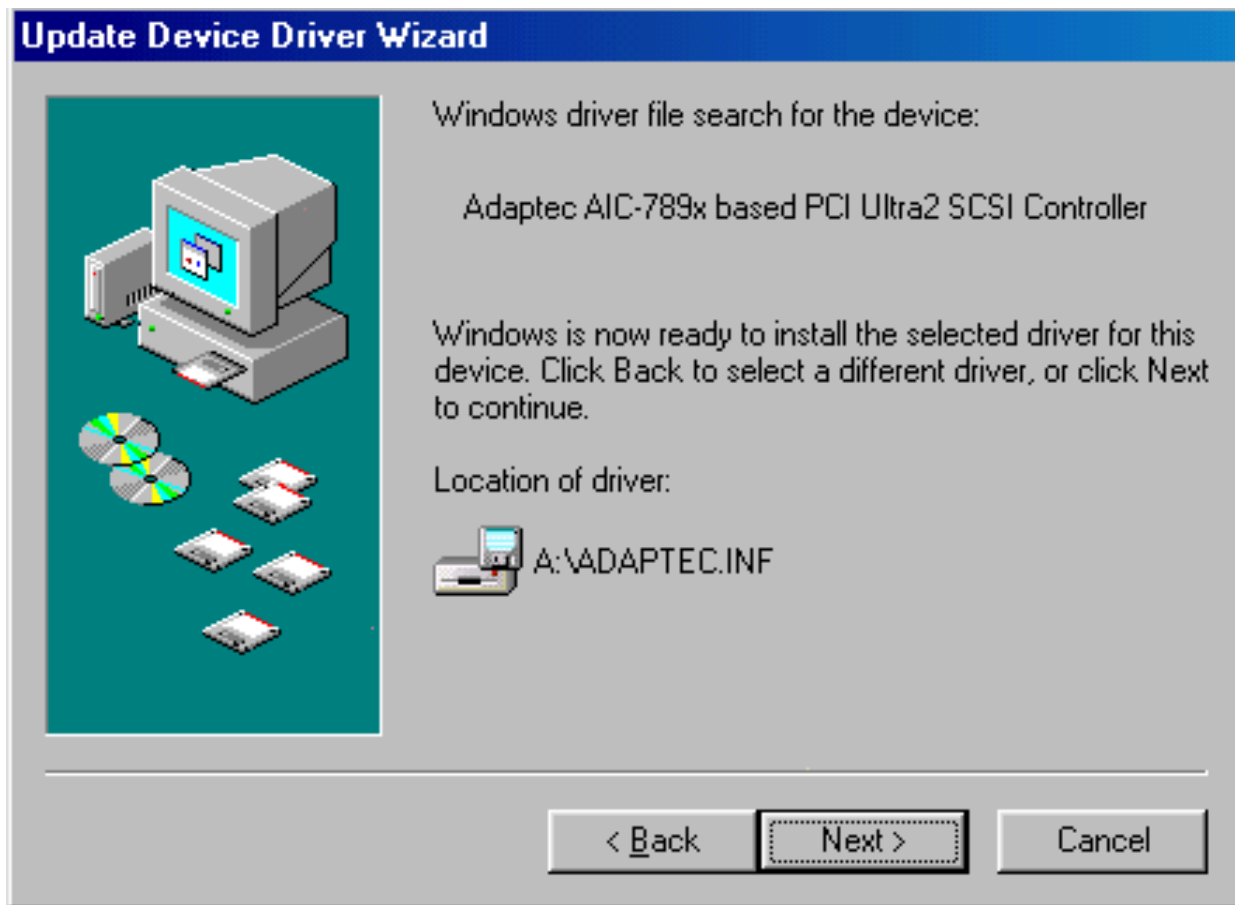

Figure 7-10: Clicking on the Next button

## 7.2 Windows NT Drivers Setup Procedure

1. In the "Control Panel" screen, select the "SCSI Adapters" icon.



Figure 7-12: Clicking on SCSI Adapters icon

2. Click on "Add" in the SCSI Adapters window.

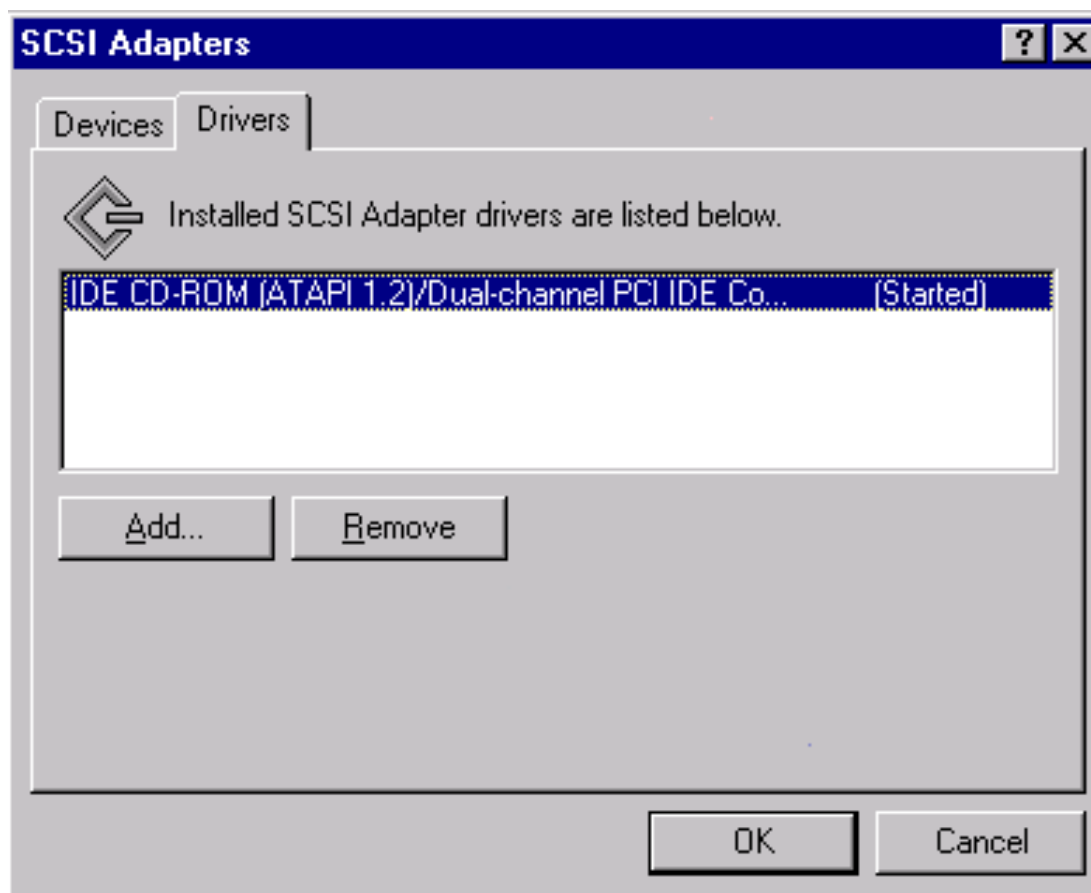

Figure 7-13: Clicking on the Add button

3. Click on "Have Disk..." in the Install Driver window.

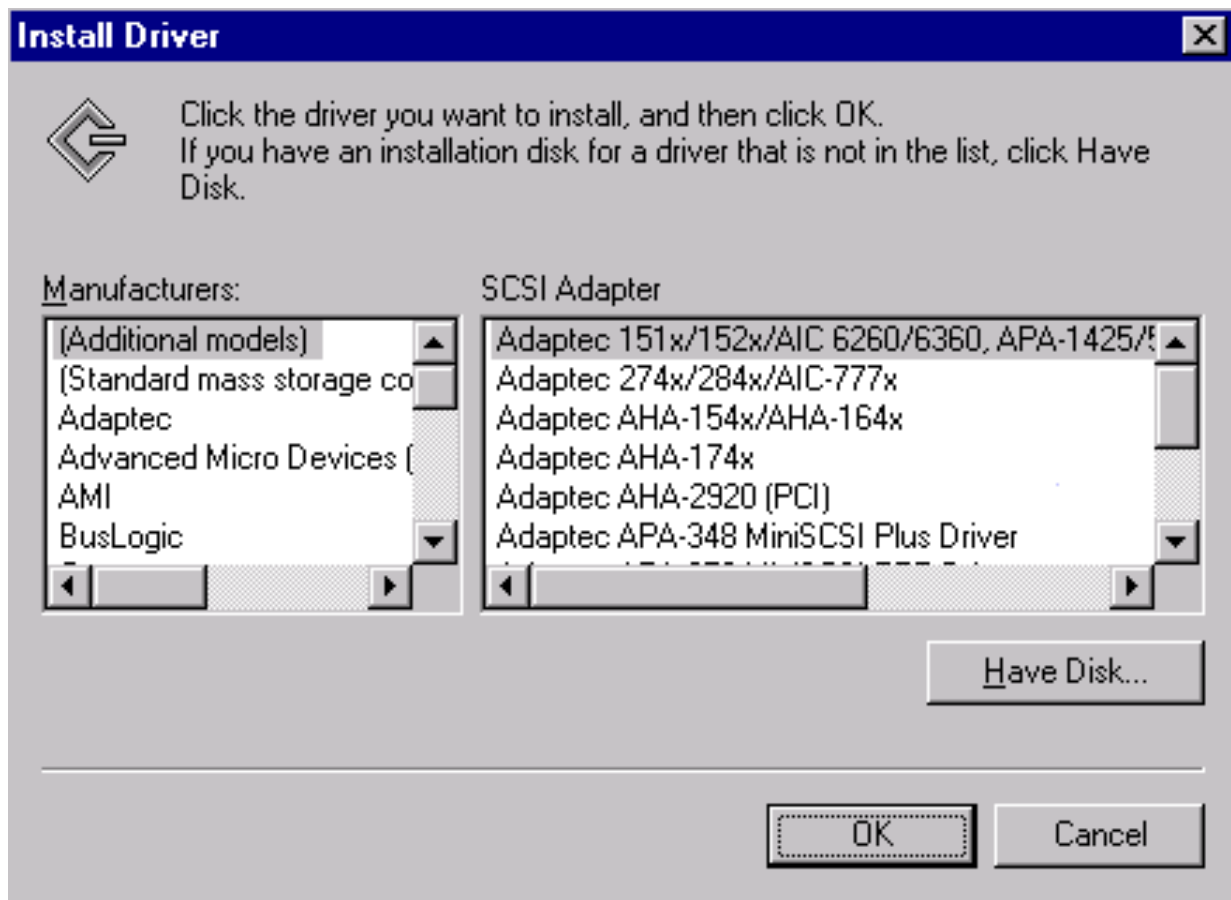

Figure 7-14: Clicking on the Have Disk button

4. Click on "Browse..." to look for the driver program.

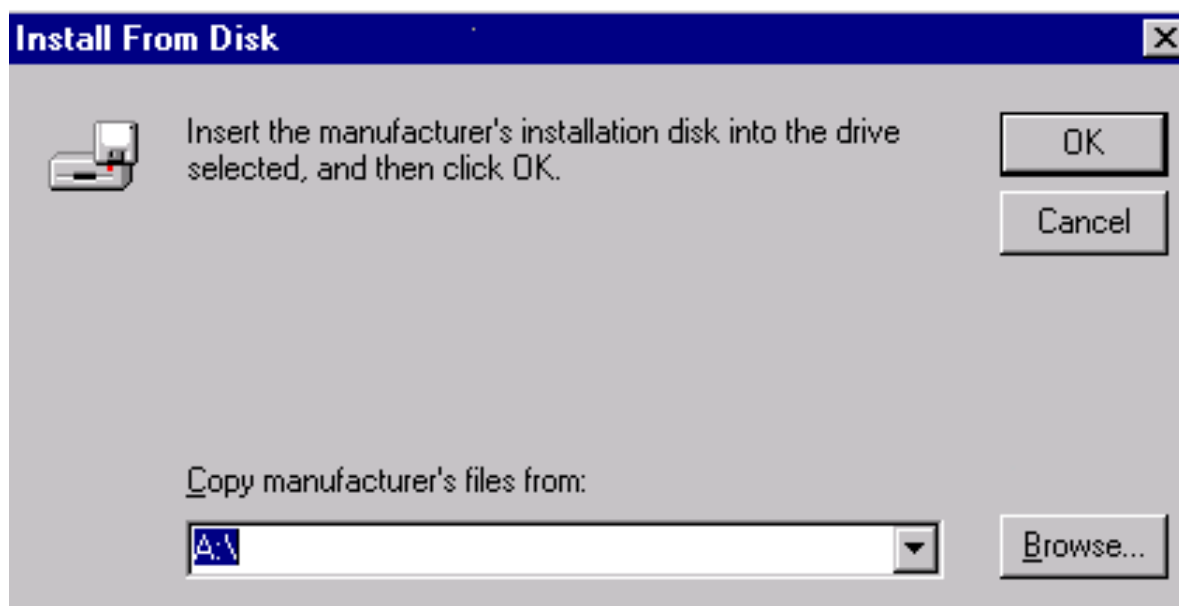

Figure 7-15: Clicking on the Browse button

5. Open "Winnt" folder.

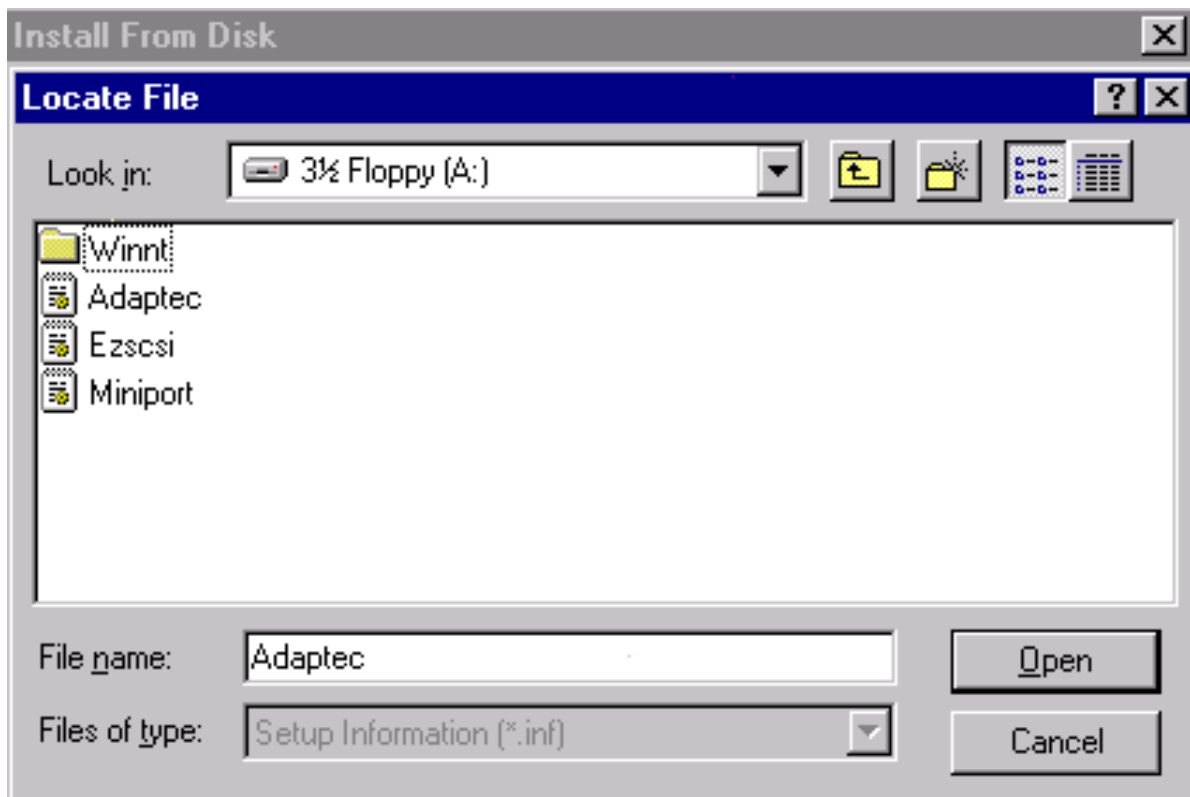

Figure 7-16: Opening the Winnt folder

6. Click "Open" in the "Locate File" window.

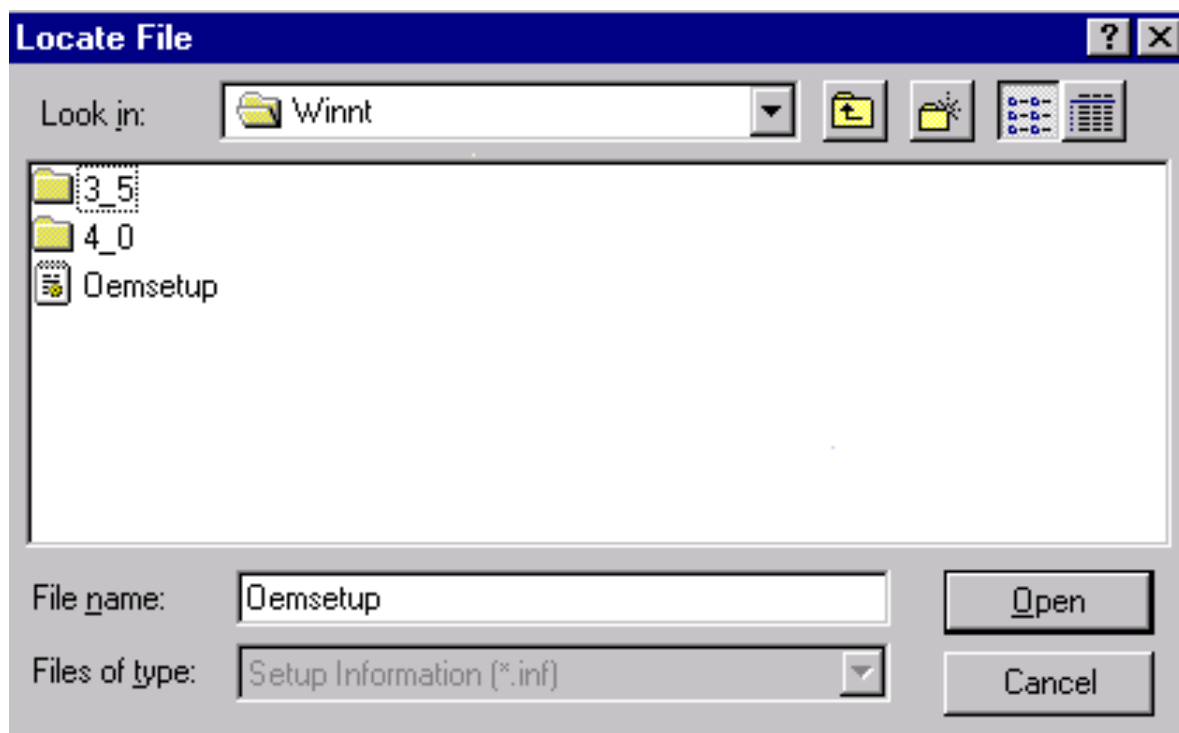

Figure 7-17: Clicking on the open button

6. Click "Browse" icon.

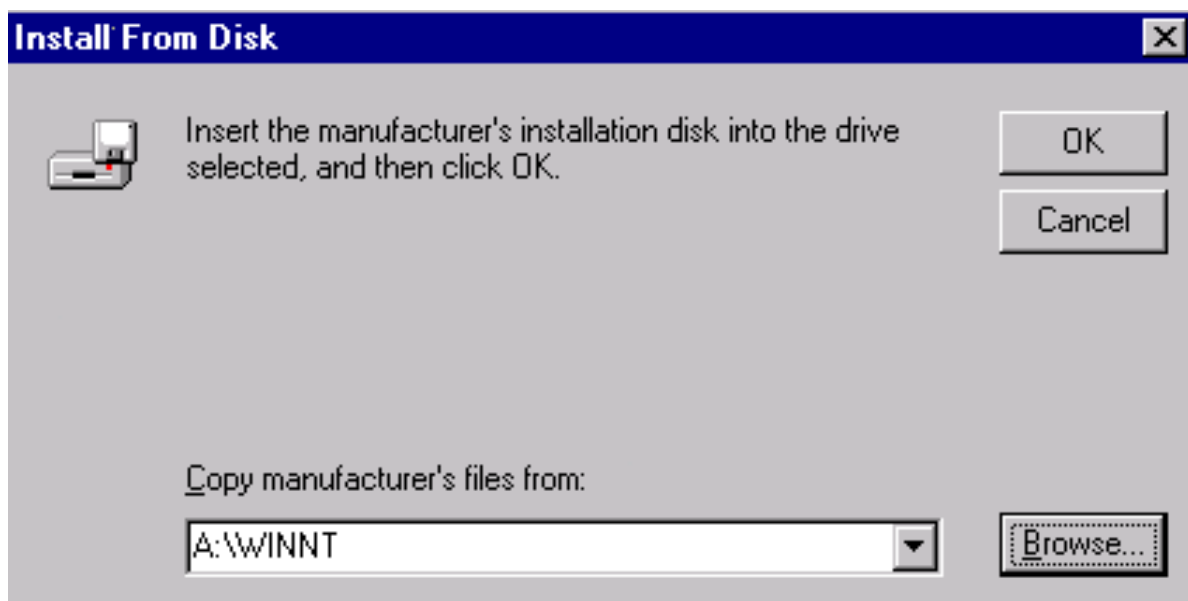

Figure 7-18: Clicking the Browse icon

7. Choose the "Adaptec PCI Ultra 2 SCSI Controller (NT 4.0): ..." and then click "Ok".

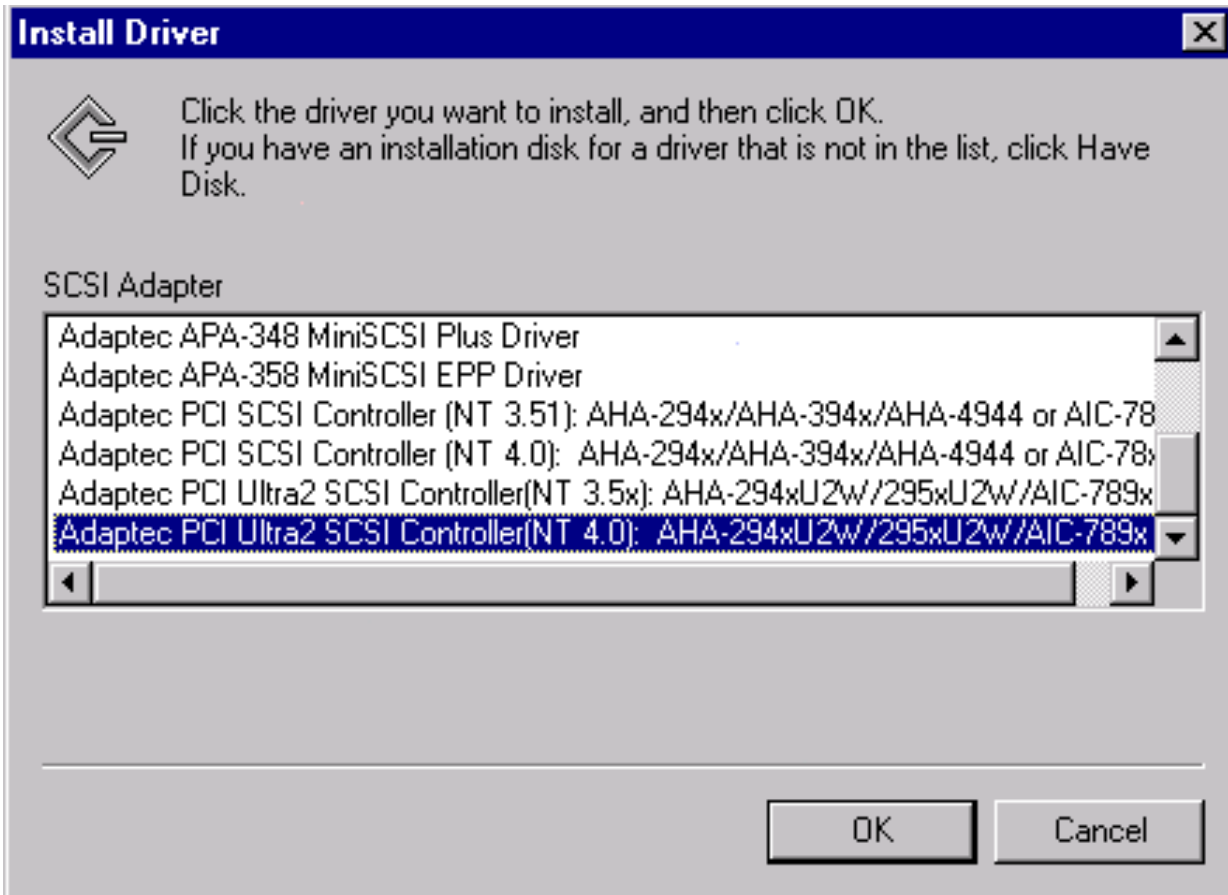

Figure 7-19: Choosing SCSI Adapter and clicking on the OK button

8. Key in "a:\winnt\4\_0" and then click Continue.

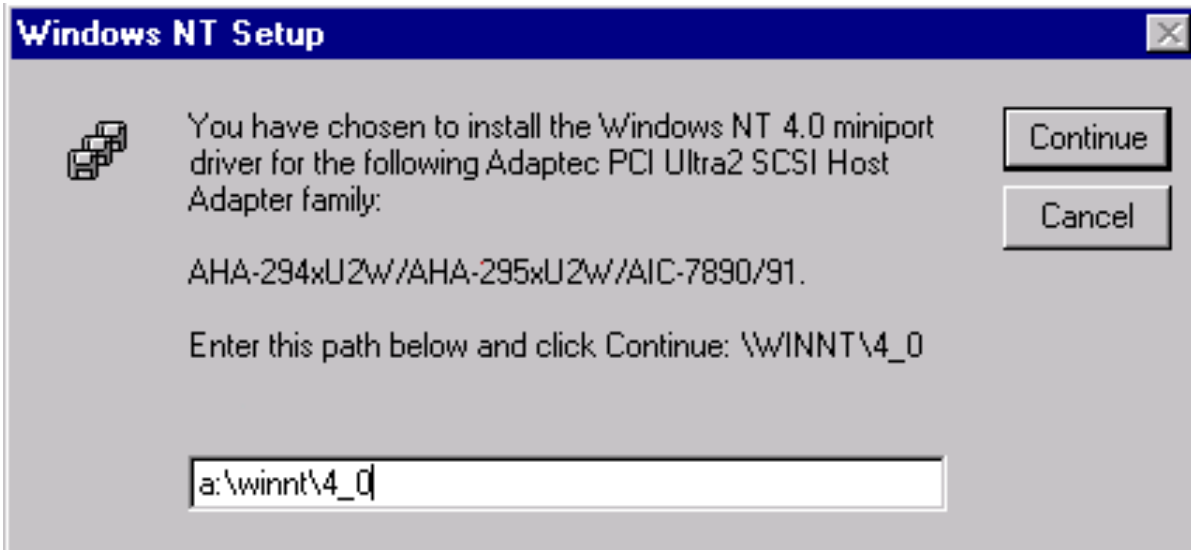

Figure 7-20: Entering the path below and clicking Continue

9. Click "Yes" to restart computer and the driver is installed.

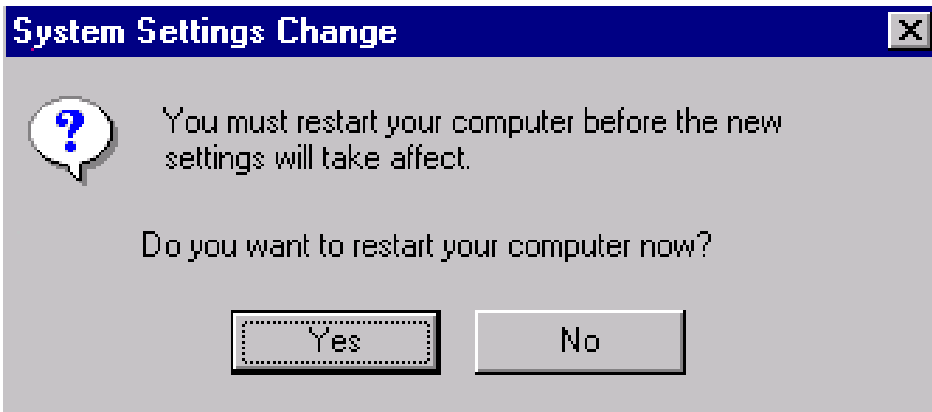

Figure 7-21: Clicking the Yes button to restart the computer

## Appendix 1

# Watch Dog Timer

### Watch Dog Timer Working Procedure

The Watch Dog Timer (WDT) is the special hardware device. The WDT function is to monitor the computer system whether work normally, otherwise, it will have some measures to fix up the system.

It contains a receivable SQW signal from RTC, and could set time and can clear the counter function. When time is up, WDT can send Reset or NMI signal.

Operator has to write a value into WDT Configuration Register (Write the control value to the Configuration Port), and clear WDT counter (read the Configuration Port).

### Watch Dog Timer character and function

WDT Configuration port	F2	Default at F2
Watch Dog Timer	Disabled Enabled	1. Default at disabled 2. Enabled for user's programming
WDT Time out active for	Reset NMI	Default at Reset
WDT Active Time	1 sec 2 sec 4 sec 8 sec 16 sec 32 sec 64 sec	Default at 64 sec

## Watch Dog Timer Control Register

The Watch Dog Timer Control Register is to control the WDT working mode. You can write the value to WDT Configuration Port.

The following is the Control Register bit definition.

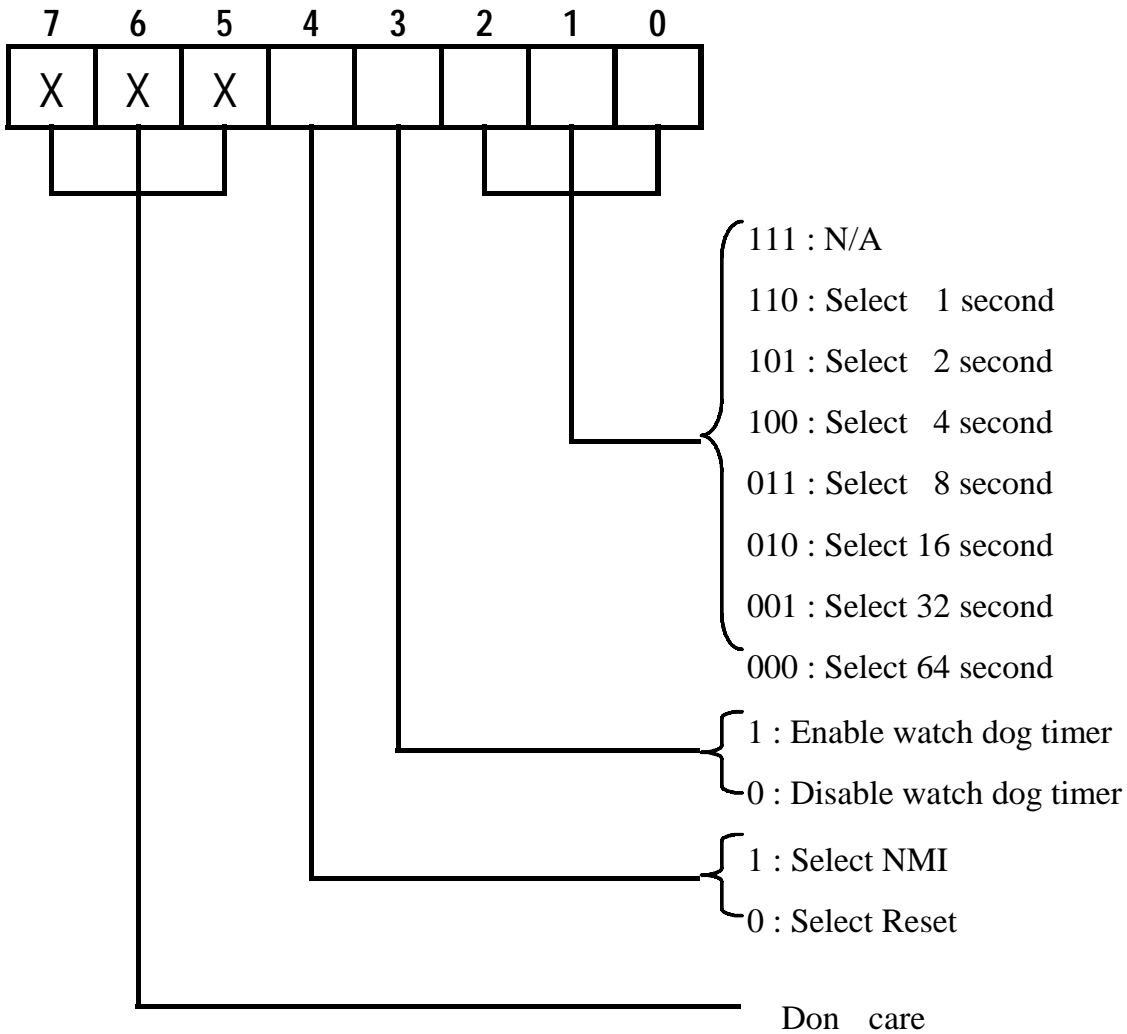

## Watch Dog Timer Programming Procedure

### • Power on or reset the system

The initial value of WDT Control Register (D4~D0) is zero, when power is on or reset the system. The following means the initial value of WDT ( 00000000b ) :

Bit	Value	Mean
4	0	Select Reset
3	0	Disable watch dog timer
2, 1, 0	0 0 0	Select 64 second

### • Initialize the SQW of RTC (set SQW output period=0.5 second)

To initialize the SQW of RTC processor is to set the SQW signal which is output period=0.5 second. It offers the basic frequency of the WDT counter.

The following is an example of **initializing the SQW signal program** in Intel 8086 assembly language.

```
; (Generate SQW = 0.5 Sec.)  
Mov dx, 70h  
Mov ax, 0Ah  
Out dx, al      ; Out port 70h = 0Ah  
Mov dx, 71h  
Mov ax, 2Fh  
Out dx, al      ; Out port 71h = 2Fh  
; (enable the SQW output)  
Mov dx, 70h  
Mov ax, 0Bh  
Out dx, al      ; Out port 70h = 0Bh
```

```
Mov dx, 71h
Mov ax, 0Ah
Out dx, al ; Out port 71h = 0Ah
```

### • Clear the WDT

Repeatedly read WDT Configuration Port and the interval cannot be longer than the preset time, otherwise, the WDT will generate NMI or Reset signal for the system.

The following is an example of **clear the WDT program** in Intel 8086 assembly language.

```
; ( Clear the WDT)
Mov dx, F2h ;Setting the WDT configuration port
In al, dx
```

**Note:** Before running WDT, you must clear the WDT. It means to make sure the initial value is zero before enabling the WDT.

### • WDT Control Register (Write to WDT configuration port)

You can set the WDT Control Register to control the WDT working mode.

The initial value of the WDT Control Register is as the following.

```
; (Setting the WDT Control Register as AL)
Mov al, 0h ; Setting initial value = 0 for the WDT Control Register
```

You must plan the option of following:

1. Select NMI or Reset: decide D4 value in F2.

i.e. Setting D4 = 0, then it select Reset

```
AND al, 11101111b ; Select Reset
```

i.e. Setting D4 = 1, then it select NMI

```
OR al, 00010000b ; Select NMI
```

2. Select the time-out intervals of WDT (decide the values of D2, D1, D0 in F2 )

Example: D2~D0 = 0, the time-out interval will be 64 sec.

```
AND    al, 11111000b    ; Setting the time-out interval as 64 sec.
```

3. Enable or Disable the WDT ( decide D3 value in F2)

i.e. D3=0, Disable the WDT

```
AND    al, 11110111b    ; Disable the WDT
```

i.e. D3=1, Enable the WDT

```
OR     al, 00001000b    ; Enable the WDT
```

After finishing the above setting, you must be output for the Control Register value to the WDT Configuration Port. Then WDT will start according to the above setting.

```
MOV    dx, F2h          ; Setting WDT Configuration Port
OUT    dx, al           ; Output the Control Register Value
```

- You should build in a mechanism in the program to continue to read the WDT Configuration Port for clearing WDT before the time out.

## Appendix 2

### Memory Mapping