

# **NEX 6420A**

**ATX Industry Server Board**

**User's Guide**

## **@Copyright 2000**

All Rights Reserved

Manual edition 1, September 2000

The information in this document is subject to change without prior notice in order to improve reliability, design and function and does not represent commitment on the part of the manufacturer.

In no event will the manufacturer be liable for direct, indirect, special, incidental, or consequential damages arising out of the use or the possibility of such damages.

This document contains proprietary information protected by copyright. All rights are reserved. No part of this manual may be reproduced by any mechanical, electronic, or other means in any form without prior written permission of the manufacturer.

# How to use this guide

This manual is written to help you use NEX 6420A. It describes how to arrange various settings on the Pentium CPU board to meet your requirements. It is briefed as follows:

**Chapter 1, "Introduction"** gives an overview of the product's specifications. It also tells you what are included in the product package.

**Chapter 2, "Switches and Connectors"** describes the definitions and positions of Jumpers and Connectors that you may easily configure and set up per your requirement.

**Chapter 3, "Capability Expanding"** describes how to change or expand the CPU Board by changing the system memory, cache memory, and CPU to get more power out from the CPU board.

**Chapter 4, "Award BIOS Setup"** describes how to use the advanced PCI/Green BIOS to control almost every feature of the NEX 6420A, including the watchdog timer.

The Appendix 1 describes how to set up the Watch Dog Timer (WDT) and gives an example to program the WDT.

---

# Contents

<b>CHAPTER 1 INTRODUCTION .....</b>	<b>1-1</b>
<b>1-1 Specifications.....</b>	<b>1-2</b>
<b>1-2 What you'll have from the package.....</b>	<b>1-6</b>
<b>CHAPTER 2 SWITCHES AND CONNECTORS.....</b>	<b>2-1</b>
<b>2-1 Main Board Layout .....</b>	<b>2-1</b>
<b>2-2 Switches .....</b>	<b>2-2</b>
<b>2-3 Connectors .....</b>	<b>2-3</b>
<b>CHAPTER 3 CAPABILITY EXPANDING .....</b>	<b>3-1</b>
<b>3-1 System Memory .....</b>	<b>3-1</b>
<b>CHAPTER 4 AWARD BIOS SETUP .....</b>	<b>4-1</b>
<b>4-1 BIOS Setup .....</b>	<b>4-1</b>
<i>Entering Setup .....</i>	<i>4-1</i>
<i>Control Keys .....</i>	<i>4-2</i>
<i>Getting Help.....</i>	<i>4-3</i>
<i>The Main Menu .....</i>	<i>4-4</i>
<i>Standard CMOS Features .....</i>	<i>4-6</i>
<i>Advanced BIOS Features Setup Menu.....</i>	<i>4-9</i>
<i>Advanced Chipset Features Setup Menu .....</i>	<i>4-13</i>
<i>Integrated Peripherals .....</i>	<i>4-15</i>
<i>Power Management Setup .....</i>	<i>4-18</i>
<i>PnP/PCI Configuration.....</i>	<i>4-22</i>
<i>PC Health Status .....</i>	<i>4-24</i>
<i>Frequency/Voltage Control.....</i>	<i>4-25</i>
<i>Supervisor/User Password Setting.....</i>	<i>4-26</i>
<i>Power-On Boot .....</i>	<i>4-27</i>
<b>4-2 BIOS Reference - POST Message .....</b>	<b>4-28</b>
<i>POST Beep.....</i>	<i>4-28</i>
<i>Error Messages .....</i>	<i>4-28</i>
<b>4-3 BIOS Reference - POST Codes.....</b>	<b>4-32</b>
<b>APPENDIX .....</b>	<b>I</b>
<b>Appendix A Watch Dog Timer .....</b>	<b>i</b>

## Chapter 1 Introduction

NEXCOM has developed a brand new product in its history, the Dual Pentium III FC-PGA, Intel 840 AGPset based all in one board with the ATX form factor. The NEX 6420A is the first model to be available.

NEXCOM has developed a brand new product in its history, the Dual Pentium III FC-PGA; Intel 840 AGPset based all-in-one main board with the ATX form factor. A new product family called the NEX series is created. The NEX 6420A, name of this new product, is the first model to be available.

The major features of the NEX 6420A are as follows:

1. Dual Pentium III FC-PGA architecture with 133 MHz FSB up to 1 GHz CPU clock.
2. Dual RAMBUS channel with 4 RIMMs, memory bandwidth up to 3.2 GB/s, memory size up to 2 GB.
3. On board built with VGA×1, intel 82559 Ethernet controller×2, and 64 bit/ 66 MHz PCI based Adaptec AIC 7899 dual channel Ultra/ 160m.
4. AGPpro slot×1 for 4×AGP, 64bit/ 66MHz PCI slot×2, and 32 bit/ 33 MHz PCI slot×3.
5. All key components are long term supplied for at least 3 years.

With all above features equipped on board, The NEX 6420A is one of the top performance DP server boards in the world. So far, it's still the smallest main board with so many features integrated on the standard ATX form factor. Without any add on cards, the NEX 6420A could out perform most of the server boards because there are 2x 100 Base TX Ethernet ports and 2x Ultra/ 160m SCSI channels on board. NEX6420 is particularly suitable for the ISP server applications. A 2U chassis could easily accommodate the NEX 6420A, and still reserve 2x 64 bit/ 66 MHz blazing PCI expansion slots. For larger server chassis, like the big tower, 5U, 6U, or even 8U rack mounted chassis, the NEX 6420A could also be applied in these cases that are ATX compatible. The reason to create the ATX server line is based on the fact that ATX form factors are used by most producers. With rigidly complying with ATX specifications, the NEX 6420A could be applied in any case requiring the top server performance, as long as it's ATX compatible.

The NEX 6420A could also be positioned as the top performing workstation. With the on board AGPpro, the 4X AGP slot reserved for any next generation 3D VGA/ Video accelerator cards, the NEX 6420A could out perform any other DP architectures. Again, the standard ATX form factor is the greatest advantage of the NEX 6420A for any workstation chassis, and it will help a lot for the NEX 6420A to be widely accepted by the power users in the compute-intensive workstation applications or the I/O intensive server applications.

## 1-1 Specifications

- **System Architecture**
  - Standard ATX form factor with dual Pentium III CPU support
  - AIO board with dual channel Ultra 160 SCSI, dual channel Ethernet and VGA
  - Next generation sever with industry specification
  
- **CPU Support**
  - Intel Dual Pentium III CPU with 128/256K cache on die
  - Brand New Socket 370 FC-PGA CPU running at 100/133MHz FSB up to 1GHz
  - Support streaming SIMD instruction
  
- **Main Memory**
  - Support RDRAM up to 2GB (Max.)
  - Two direct RDRAM channels support up to 3.2GB/s of data bandwidth
  - 184 pin RIMM socket × 4
  - ECC support (single bit error correction/Multiple bit errors reporting)
  
- **BIOS**
  - Award System BIOS
  - Plug & Play support
  - Advanced Power Management support
  - Advanced Configuration & Power Interface support
  - Jumperless for CPU FSB
  - 4M bits flash ROM, upgradeable to 8M bits
  
- **Chip Set**
  - Intel 840 Chipset support up to 2-way configurations
  - 64bit and 66MHz PCI interface
  - 82840 ×1 Memory Controller Hub (MCH)
  - 82801 ×1 I/O Controller Hub (ICH)
  - 82802 ×1 Firmware Hub (FWH)
  - 82806 ×1 64 bit PCI Controller Hub (P64H)

- **On Board VGA**

- C&T 69000 VGA controller (PCI mode)
- 2MB SDRAM on die
- Maximum Res. Color & Refresh Rate

Resolution	Colors	Refresh Rate (Hz)
1280×1024	256	60
1024×768	16bits (High color)	85, 75, 60
800×600	24bits (True color)	85, 75, 60

- Drivers support : Windows 95/98, Windows NT4.0

- **On Board LAN**

- Intel 82559 Single Ethernet controller ×2
- 10 Base T/100 Base TX support, full duplex
- Complied with PCI V2.1, IEEE802.3, IEEE 802.3U
- Drivers support : DOS/Windows, Windows 95/98/2000, Windows NT4.0, Netware, SCO Open Server 5.0, Linux
- Rear Panel 4 LAN LED (active/link × 2, speed × 2)

- **On Board SCSI**

- Adaptec AIC 7899 dual channel Ultra 160 SCSI controller
- Brand New Ultra 160 SCSI support
- 160MB/s (Max.) transfer rate, up to 12 meter cable
- Backward compatible with Ultra Wide SCSI, SCSI II, etc.
- Drivers support : Windows 95/98, Windows NT4.0, SCO Open Server 5.0
- 68 pin SCSI connector × 2
- On board 4 pin header for LED

- **On Board I/O**

- SMSC LPC47B27x Enhanced Super I/O on board
- SIO × 2, with 2×16C550 UARTs.
- PIO × 1, Bi-directional, EPP/ECP support
- Floppy Disk controller: 5.25" 360KB/1.2MB, 3.5" 720KB/1.2MB/1.44MB/2.88MB support, 34 pin connector × 1
- On chip enhanced IDE ×2, PIO up to mode 4, DMA master up to mode 2, Ultra DMA/33/66 support, total 4 E.IDE Devices support, 40 pin connector × 2
- On chip keyboard, mouse controller
- On board USB port × 2
- On board buzzer × 1

- IrDA connector × 1
- On board 2 pin header for I2C
- On board 2 pin header for reset SW, 4 pin for speaker, 5 pin for keylock and power LED
  
- **ACPI Function**
  - Soft off
  - Wake On LAN
  - Wake On Keyboard
  - Wake On Ring
  - RTC alarm wake up
  
- **On Board Slot**
  - Total 6 slots, include AGPpro slot ×1, 64bit/66MHz PCI slot ×2 (reserved 2 horizontal PCI slot expand for 2U chassis), 32bit/33MHz PCI slot ×3
  
- **Embedded RTC**
  - Embedded RTC Support by Intel ICH chipset
  
- **IDE interface Disk On Module support**
  - On board reserved power pin for DOM (DiskOnModule) : 4MB~160MB, etc
  
- **System Monitor**
  - Winbond W83782D system monitor controller
  - 8 voltage (For +3.3V, +5V, +12V, -12V, Vtt and Vcore ×2, Vcc2.5V )
  - Two Fan speed (For CPU)
  - Two temperature (For CPU)
  - Drivers support : Windows 95/98, Windows NT4.0/2000
  
- **Back Panel**
  - PS2 connector ×2 (for Keyboard/Mouse)
  - USB port ×2
  - RJ45 connector ×2 (for LAN)
  - 15 pin D-type connector ×1 (for VGA)
  - 9 pin D-type connector ×2 (for SIO)
  - 25 pin D-type connector ×1 (for PIO)
  - LAN LED ×4 (active/link ×2, speed ×2)
  
- **Power Input**
  - ATX power connector ×1

- **Dimensions**

- Dimensions : 305mm(L) x 244mm(W)

- **Power Requirements**

- +3.3V : 10A
- +5V : 20A
- +12V : 500mA
- 5VSTBY : 1A

- **Environments**

- Operating temperatures : 0°C to 60°C
- Storage temperatures : -20°C to 80°C
- Relative humidity : 10% to 90% (Non-condensing)

- **Certification**

- CE approval
- FCC Class A

- **Model Available**

- NEX 6420A -- ATX Dual Socket 370 Pentium III AIO Main Board
- NEX 6420VL2 -- ATX Dual Socket 370 Pentium III Main Board w/VGA/Dual LAN
- NEX 6420 -- ATX Dual Socket 370 Pentium III Main Board

## 1-2 What you'll have from the package

In addition to this manual, the NEX 6420A series package includes the following items.

ITEM \ Model	NEX 6420A	NEX 6420VL2	NEX 6420
NEX 6420 series ATX Server Board	1	1	1
IDE Cable Set (Ultra DMA 66, DMA33, FDD )	1	1	1
SCSI Cable	Optional	×	×
RIMM Continuity Module	2	2	2
Driver CD	1	1	1
Rear I/O Gasket	1	1	1

If any of these items is missed or damaged, please contact your vendor for what you want

# Chapter 2 Switches and Connectors

## 2-1 Main Board Layout

This chapter gives the definitions and shows where to locate the positions of switches and connectors.

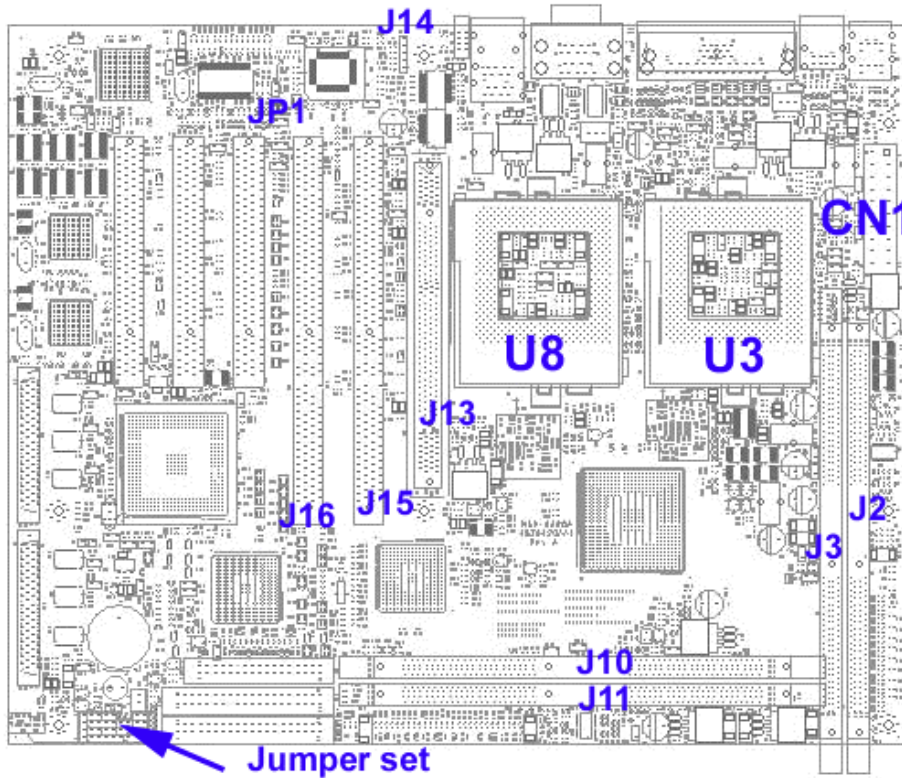

**Jumper Set:**

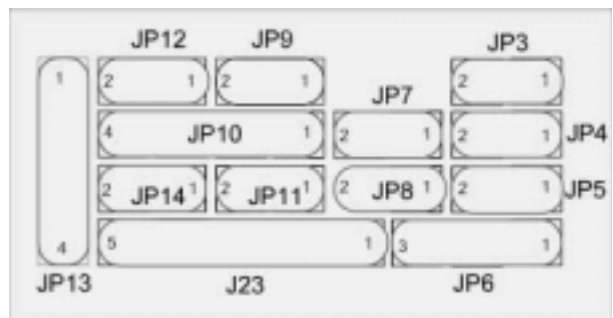

## 2-2 Switches

Switches on the CPU board are used to select options for different functions used. The switch-on or off is to accommodate the variations of the following table.

### Switch Setting Table

#### COMS Jumper

Pin No.	Normal	Clear CMOS
1-2	<b>ON</b>	OFF
2-3	<b>OFF</b>	ON

#### Power Switch

	Normal	Trigger State
JP4	OFF	<b>ON</b>

#### JP9: FWH Write Protection Connector

	Write Protection	Write Enable
JP9	OFF	<b>ON</b>

#### JP12: Reset Button

	Normal	Reset
JP12	OFF	ON

#### JP3: Intruder Switch

	Normal	Intruder Detected
JP3	OFF	ON

#### JP4: Power Switch

	Normal	Trigger State
JP4	OFF	ON

## 2-3 Connectors

### Jumper/Connector Define

- U8:** Boot Processor Socket  
**U3:** Application Processor Socket  
**CN1:** ATX Power Connector  
**J10/J11:** CHANNEL A RIMM CONNECTOR  
**J3/J2:** CHANNEL B RIMM CONNECTOR  
**J13:** AGP PRO Connector  
**JP6:** COMS Jumper

Pin No.	Normal	Clear CMOS
1-2	ON	OFF
2-3	OFF	ON

**J15/16:** 64 Bits PCI Slot

**J18:** Floppy Disk Connector

Pin No.	Normal	Clear CMOS
1-2	ON	OFF
2-3	OFF	ON

**J15/16:** 64 Bits PCI Slot

**J18:** Floppy Disk Connector

PIN No.	Description	PIN No.	Description
1	Ground	2	Index Pulse Input
3	Ground	4	Drive Select 0
5	Ground	6	Disk Change
7	N/A	8	N/A
9	N/A	10	Motor On 0
11	N/A	12	Step Direction
13	Drive Density Select 0	14	Step Pulse
15	Ground	16	Write Disk Data
17	Ground	18	Write Gate
19	Ground	20	Track 0
21	Ground	22	Write Protected
23	Ground	24	Read Disk Data
25	Ground	26	Head Select

**J1:** PS/2 Keyboard & Mouse Connector

PIN No.	Description	
	Below Connector	Upper Connector
1	Keyboard Data	PS/2 Mouse Data
2	NC	NC
3	Ground	Ground
4	+5V	+5V
5	Keyboard Clock	PS/2 Mouse Clock
6	NC	NC

**J9:** Serial Port 1/2 Connector

PIN No.	Description
1	Data Carrier Detect (DCD)
2	Receive Data (RXD)
3	Transmit Data (TXD)
4	Data Terminal Ready (DTR)
5	Ground (GND)
6	Data Set Ready (DSR)
7	Request to Send (RTS)
8	Clear to Send (CTS)
9	Ring Indicator (RI)

**J7:** Parallel Port Connector

PIN No.	Description	PIN No.	Description
1	Strobe#	2	Data 0
3	Data 1	4	Data 2
5	Data 3	6	Data 4
7	Data 5	8	Data 6
9	Data 7	10	Acknowledge
11	Busy	12	Paper Empty
13	Printer Select	14	Auto Form Feed#
15	Error#	16	Initialize
17	Printer Select IN#	18	Ground
19	Ground	20	Ground
21	Ground	22	Ground
23	Ground	24	Ground
25	Ground		

**J19:** Primary IDE Connector

PIN No.	Description	PIN No.	Description
1	Reset #	2	Ground
3	Data 7	4	Data 8
5	Data 6	6	Data 9
7	Data 5	8	Data 10
9	Data 4	10	Data 11
11	Data 3	12	Data 12
13	Data 2	14	Data 13
15	Data 1	16	Data 14
17	Data 0	18	Data 15
19	Ground	20	N/C
21	DMA REQ	22	Ground
23	IOW	24	Ground
25	IOR	26	Ground
27	IOCHRDY	28	Pull Down
29	DMA ACK	30	Ground
31	Interrupt 14	32	N/C
33	Disk Address 1	34	DMA66 Detect
35	Disk Address 0	36	Disk Address 2
37	HDC CS100	38	HDC CS300
39	HDD Active Led	40	Ground

**J20:** Secondary IDE Connector

PIN No.	Description	PIN No.	Description
1	Reset #	2	Ground
3	Data 7	4	Data 8
5	Data 6	6	Data 9
7	Data 5	8	Data 10
9	Data 4	10	Data 11
11	Data 3	12	Data 12
13	Data 2	14	Data 13
15	Data 1	16	Data 14
17	Data 0	18	Data 15
19	Ground	20	N/C
21	DMA REQ	22	Ground
23	IOW	24	Ground
25	IOR	26	Ground
27	IOCHRDY	28	Pull Down
29	DMA ACK	30	Ground
31	Interrupt 14	32	N/C
33	Disk Address 1	34	DMA66 Detect
35	Disk Address 0	36	Disk Address 2
37	HDC CS100	38	HDC CS300
39	HDD Active Led	40	Ground

**U13:** Fire-Ware Hub

**J4:** USB 1/2 Connector

PIN No.	Description
1/5	+5V
2/6	-Data 0
3/7	+Data 0
4/8	Ground

**J12:** LAN 1/2 Connector

PIN No	Description	PIN No	Description
1	TD +	2	TD -
3	RD +	4	TERMPANE
5	TERMPANE	6	RD -
7	TERMPANE	8	TERMPANE

**J6:** VGA Connector

PIN No.	Description	PIN No.	Description
1	Red	2	Green
3	Blue	4	N/A
5	Ground	6	Ground
7	Ground	8	Ground
9	+5V	10	Ground
11	N/A	12	DDC Data
13	Horizontal Sync	14	Vertical Sync
15	DDC Clock		

**CON2:** Channel A SCSI Connector

**CON3:** Channel B SCSI Connector

**J17/21/22:** 32 Bits PCI Slot

**J14:** IRDA Connector

PIN No.	Description	PIN No.	Description
1	+5V	2	NC
3	IR Receiver	4	Ground
5	IR Transceiver		

**J5/8:** CPU FAN Connector

PIN No.	Description	PIN No.	Description
1	+5V	2	NC
3	Fans Speed Detect		

**JP10:** On Board Buzzer Jumper or Speaker Connector

Pin No.	External Buzzer	Internal Buzzer
3-4	OFF	ON

**JP7:** IDE LED Connector

PIN No.	Description	PIN No.	Description
1	Pull High	2	Active Signal

**JP9:** FWH Write Protection Connector

PIN No.	Description	PIN No.	Description
1	Pull High	2	Active Signal

**JP2:** DOM (Disk On Module) Power Connector

PIN No.	Description	PIN No.	Description
1	Ground	2	+5V

**JP12:** Reset Button

PIN No.	Description	PIN No.	Description
1	Ground	2	Reset Signal

**J23:** Key Board Lock

PIN No.	Description	PIN No.	Description
1	Pull High	2	NC
3	Ground	4	Active Signal
5	Ground		

**JP3:** Intruder Switch

PIN No.	Description	PIN No.	Description
1	Ground	2	Active Signal

**JP4:** Power Switch

PIN No.	Description	PIN No.	Description
1	Ground	2	Active Signal

**JP13.1:** SCSI Channel A LED

PIN No.	Description	PIN No.	Description
1	Pull High	2	Active Signal

**JP13.2:** SCSI Channel B LED

PIN No.	Description	PIN No.	Description
3	Pull High	4	Active Signal

**JP8:** SMBUS Connector

PIN No.	Description	PIN No.	Description
1	Data	2	Clock

**JP5:** S0 LED

PIN No.	Description	PIN No.	Description
1	Active Signal	2	Pull High

**JP11:** S5 LED

PIN No.	Description	PIN No.	Description
1	Active Signal	2	Pull High

**JP14:** S3 LED

PIN No.	Description	PIN No.	Description
1	Active Signal	2	Pull High

This page is intentionally left blank.

## Chapter 3 Capability Expanding

This chapter explains how you can expand capability of your CPU board in such aspects as system memory and CPU.

### 3-1 System Memory

NEX 6420A series can install from 128 MB to 1 GB of PC600 or PC800 RDRAM into the four RIMM sockets. The Max. Support Memory size of 2 GB may be supported with the availability of 512 MB RIMM.

The following table is the currently available RIMM Module technology:

Device / RIMM	64Mbit	128Mbit	256Mbit
4	N/A	64MB Module	128MB Module
8	N/A	128MB Module	256MB Module
16	128MB Module	256MB Module	512MB Module

### Memory Configuration

The NEX 6420A has two RDRAM channels, in which a total of four RIMMs may be installed. When using only two RIMMs, you must install a Rambus RIMM Continuity Module in those slots that do not contain RDRAM Memory Module.

In order to optimize memory performance, you must first populate RIMM-1 and RIMM-3, and RIMMs must be installed as described in the table, otherwise the Board will not boot.

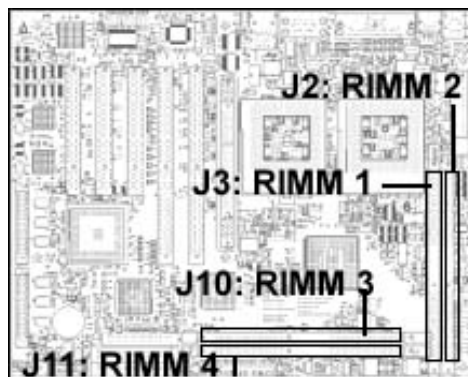

## RIMM-C : Rambus RIMM Continuity Module

RIMM 1	RIMM 2	RIMM 3	RIMM 4	Total Size
128MB	RIMM-C	128MB	RIMM-C	256MB
256MB	RIMM-C	256MB	RIMM-C	512MB
128MB	128MB	128MB	128MB	512MB
256MB	256MB	256MB	256MB	1GB

**Note 1:**

Make sure the memory in RIMM-1 and RIMM-3 must be the same size, density, type, and speed. The memory in RIMM-2 and RIMM-4 must be the same size, density, type and speed.

**Note 2:**

It also could be possible with the different size for channel 1 and Channel 2 as follow example. The most important thing is the RIMM 1 and RIMM 3 should be the same, RIMM 2 and RIMM 4 should be the same.

RIMM 1	RIMM 2	RIMM 3	RIMM 4	Total Size
128MB	256MB	128MB	256MB	768MB
256MB	128MB	256MB	128MB	768MB

## **Installing RIMM**

To install the RIMM's, first make sure the two handles of the RIMM socket are in the "open" position, i.e. the handles stay outward. Slowly slide the RIMM modules along the plastic guides in the both ends of the socket. Then press the RIMM module down right into the socket, until a click is heard. That means the two handles automatically locked the memory modules into the right position of the RIMM socket as Figure shows.

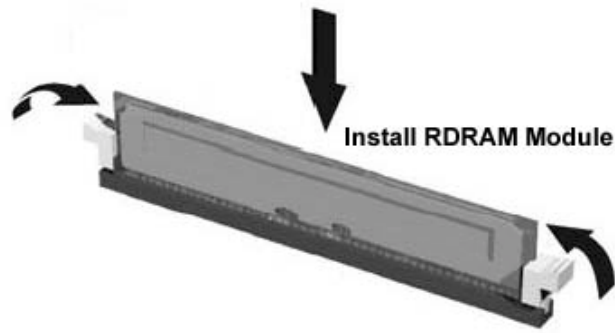

## **Remove RIMMs**

To take away the memory module, just push the both handles outward, the memory module will be ejected by the mechanism in the socket.

This page is intentionally left blank.

## Chapter 4 AWARD BIOS Setup

Award's BIOS ROM has a built-in Setup program that allows users to modify the basic system configuration. This type of information is stored in battery-backed RAM (CMOS RAM) so that it retains the Setup information when the power is turned off.

### 4-1 BIOS Setup

#### **Entering Setup**





















Power on the computer and press **<Del>** immediately will allow you to enter Setup. The other way to enter Setup is to power on the computer, when the below message appears briefly at the bottom of the screen during the POST (Power On Self Test), press **<Del>** key or simultaneously press **<Ctrl>**, **<Alt>**, and **<Esc>** keys.

**TO ENTER SETUP BEFORE BOOT  
PRESS <CTRL-ALT-ESC> OR <DEL> KEY**

If the message disappears before you respond and you still wish to enter Setup, restart the system to try again by turning it OFF then ON or pressing the "RESET" button on the system case. You may also restart by simultaneously pressing **<Ctrl>**, **<Alt>**, and **<Delete>** keys. If you do not press the keys at the correct time and the system does not boot, an error message will be displayed and you will again be asked to,

**PRESS <F1> TO CONTINUE,  
<CTRL-ALT-ESC> OR <DEL> TO ENTER SETUP**

**Control Keys**

Up arrow		Move to previous item
Down arrow		Move to next item
Left arrow		Move to the item in the left hand
Right arrow		Move to the item in the right hand
Esc key		Main Menu -- Quit and not save changes into CMOS Status Page Setup Menu and Option Page Setup Menu -- Exit current page and return to Main Menu
PgUp / "+" key	 / 	Increase the numeric value or make changes
PgDn / "-" key	 / 	Decrease the numeric value or make changes
F1 key		General help, only for Status Page Setup Menu and Option Page Setup Menu
(Shift)F2 key	 (  )	Change color from total 16 colors. F2 to select color forward, (Shift) F2 to select color backward
F3 key		Reserved
F4 key		Reserved
F5 key		Restore the previous CMOS value from CMOS, only for Option Page Setup Menu
F6 key		Load the default CMOS value from BIOS default table, only for Option Page Setup Menu
F7 key		Load the Setup default , only for Option Page Setup Menu
F8 key		Reserved
F9 key		Reserved
F10 key		Save all the CMOS changes, only for Main Menu

**Table 4-1 Control Keys**

## **Getting Help**

### **Main Menu**

The on-line description of the highlighted setup function is displayed at the bottom of the screen.

### **Status Page Setup Menu/Option Page Setup Menu**

Press <F1> to pop up a small help window that describes the appropriate keys to use and the possible selections for the highlighted item. To exit the Help Window press <F1> or <Esc>.

## **The Main Menu**

Once you enter Award BIOS CMOS Setup Utility, the Main Menu (Figure 1) will appear on the screen. The Main Menu allows you to select from ten setup functions and two exit choices. Use arrow keys to select among the items and press **<Enter>** to accept or enter the sub-menu.

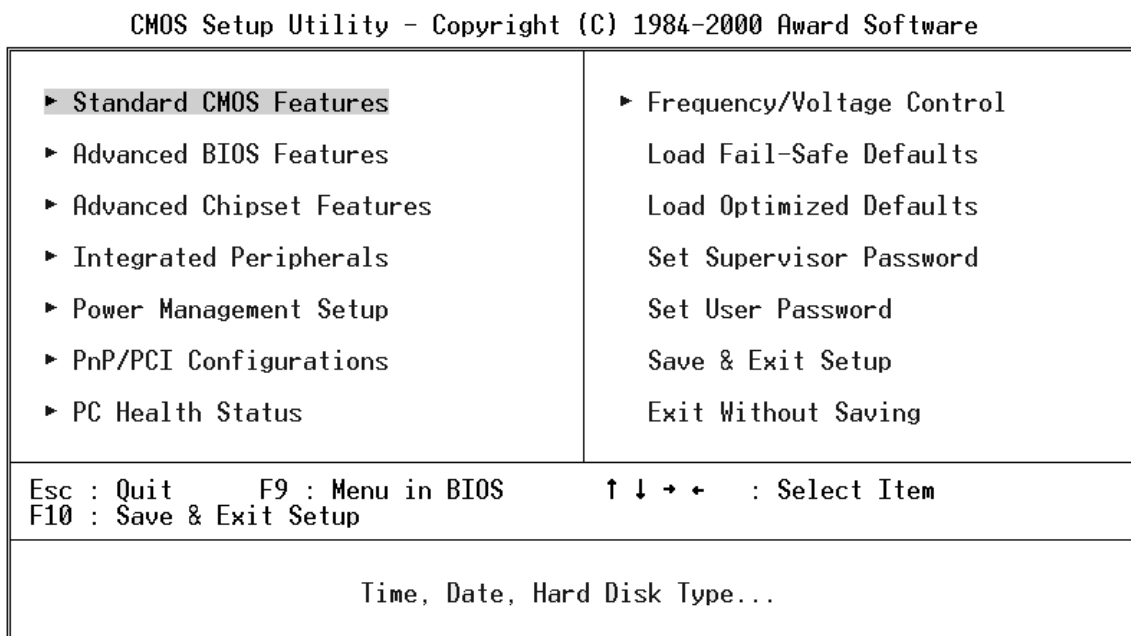

### **Standard CMOS Features**

Use this menu for basic system configuration. See Page 4-6 for details.

### **Advanced BIOS Features**

Use this menu to set the Advanced Features available on your system. See Page 4-9 for details.

### **Advanced Chipset features**

Use this menu to change the values in the chipset registers and optimize your system's performance. See Page 4-13 for details.

### **Integrated Peripherals**

Use this menu to specify your settings for integrated peripherals. See Page 4-15for details.

### **Power Management setup**

Use this menu to specify your settings for power management See Page 4-18 details.

**PNP/PCI Configuration**

This entry appears if your system supports PnP / PCI. See Page 4-22 details.

**PC health Status**

Display CPU/System Temperature, Fan speed. See Page 4-24 details.

**Frequency/Voltage Control**

Use this menu to specify your settings for frequency/voltage control. See Page 4-25 for details.

**Load Fail-Safe Defaults**

Use this menu to load the BIOS default values for the minimal/stable performance for your system to operate.

**Load Optimized Defaults**

Use this menu to load the BIOS default values that are factory settings for optimal performance system operations. While Award has designed the custom BIOS to maximize performance, the factory has the right to change these defaults to meet their needs.

**Set User Password**

Change, set, or disable password of supervisor or user. It allows you to limit access to the system and Setup, or just to Setup. See Page4-26 details.

**Save & Exit Setup**

Save CMOS value changes to CMOS and exit setup.

**Exit Without Saving**

Abandon all CMOS value changes and exit setup.

**Standard CMOS Features**

The items in Standard CMOS Setup Menu are divided into 10 categories. Each category includes no, one or more than one setup items. Use the arrow keys to highlight the item and then use the <PgUp> or <PgDn> keys to select the value you want in each item.

CMOS Setup Utility - Copyright (C) 1984-2000 Award Software  
Standard CMOS Features

Date (mm:dd:yy)	Wed, Sep 6 2000	Item Help
Time (hh:mm:ss)	11 : 54 : 55	
▶ IDE Primary Master		Menu Level ▶
▶ IDE Primary Slave		Change the day, month, year and century
▶ IDE Secondary Master		
▶ IDE Secondary Slave		
Drive A	1.44M, 3.5 in.	
Drive B	None	
Floppy 3 Mode Support	Disabled	
Video	EGA/VGA	
Halt On	All,But Keyboard	
Base Memory	640K	
Extended Memory	64384K	
Total Memory	65024K	

↑↓←→:Move Enter:Select +/-/PU/PD:Value F10:Save ESC:Exit F1:General Help  
F5:Previous Values F6:Fail-Safe Defaults F7:Optimized Defaults

**Main Menu Selections**

Item	Options	Description
Date	Month DD YYYY	Set the system date. Note that the 'Day' automatically changes when you set the date
Time	HH : MM : SS	Set the system time
IDE Primary Master	Options are in its sub menu (Described in Table 4-3)	Press <Enter> to enter the sub menu of detailed options
IDE Primary Slave	Options are in its sub menu (Described in Table 4-3)	Press <Enter> to enter the sub menu of detailed options
IDE Secondary	Options are in its sub menu (Described in Table 4-3)	Press <Enter> to enter the sub menu of detailed options
IDE Secondary	Options are in its sub menu (Described in Table 4-3)	Press <Enter> to enter the sub menu of detailed options
Drive A Drive B	None 360K, 5.25 in 1.2M, 5.25 in 720K, 3.5 in	Select the type of floppy disk drive installed in your system

	1.44M, 3.5 in 2.88M, 3.5 in	
Floppy 3 Mode	Disabled, Drive A, Drive B, Both	3 Mode floppy disk drives (FDD) are 3 1/2" drives used in Japanese computer systems. If you need to access data stored in this kind of floppy, you must select this mode, and of course you must have a 3 Mode floppy drive.
Video	EGA/VGA CGA 40 CGA 80 MONO	Select the default video device
Halt On	All Errors No Errors All, but Keyboard All, but Diskette All, but Disk/Key	Select the situation in which you want the BIOS to stop the POST process and notify you
Base Memory	N/A	Displays the amount of conventional memory detected during boot up
Extended Memory	N/A	Displays the amount of extended memory detected during boot up
Total Memory	N/A	Displays the total memory available in the system

Table 4-2 Main Menu Selections

## IDE Adapters

The IDE adapters control the hard disk drive. Use a separate sub menu to configure each hard disk drive. Use the legend keys to navigate through this menu and exit to the main menu. Use Table 3 to configure the hard disk.

Item	Options	Description
IDE HDD Auto-detection	Press Enter	Press Enter to auto-detect the HDD on this channel. If detection is successful, it fills the remaining fields on this menu.
IDE Primary Master	None Auto Manual	Selecting 'manual' lets you set the remaining fields on this screen. Selects the type of fixed disk. "User Type" will let you select the number of cylinders, heads, etc. Note: PRECOMP=65535 means NONE !
Capacity	Auto Display your disk drive size	Disk drive capacity (Approximated). Note that this size is usually slightly greater than the size of a formatted disk given by a disk checking program.
Access Mode	Normal LBA Large Auto	Choose the access mode for this hard disk
<b>The following options are selectable only if the 'IDE Primary Master' item is set to 'Manual'</b>		
Cylinder	Min = 0 Max = 65535	Set the number of cylinders for this hard disk.
Head	Min = 0 Max = 255	Set the number of read/write heads
Precomp	Min = 0 Max = 65535	**** Warning: Setting a value of 65535 means no hard disk
Landing zone	Min = 0 Max = 65535	****
Sector	Min = 0 Max = 255	Number of sectors per track

**Table 4-3 Hard disk selections**

**Advanced BIOS Features Setup Menu**

This section allows you to configure your system for basic operation. You have the opportunity to select the system's default speed, boot-up sequence, keyboard operation, shadowing and security.

CMOS Setup Utility - Copyright (C) 1984-2000 Award Software  
Advanced BIOS Features

Virus Warning	Disabled	▲ ▼	Item Help
CPU Internal Cache	Enabled		Menu Level ▶
External Cache	Enabled		Allows you to choose the VIRUS warning feature for IDE Hard Disk boot sector protection. If this function is enabled and someone attempt to write data into this area, BIOS will show a warning message on screen and alarm beep
CPU L2 Cache ECC Checking	Enabled		
Processor Number Feature	Enabled		
Quick Power On Self Test	Disabled		
Onboard Lan Boot ROM	Disabled		
First Boot Device	Floppy		
Second Boot Device	HDD-0		
Third Boot Device	LS120		
Boot Other Device	Enabled		
Swap Floppy Drive	Disabled		
Boot Up Floppy Seek	Enabled		
Boot Up NumLock Status	On		
Gate A20 Option	Fast		
Typematic Rate Setting	Enabled		
Typematic Rate (Chars/Sec)	30		
Typematic Delay (Msec)	250		
Security Option	Setup		
MPS Version Control For OS	1.1		
OS Select For DRAM > 64MB	Non-OS2		
HDD S.M.A.R.T. Capability	Disabled		
Video BIOS Shadow	Enabled		
C8000-CBFFF Shadow	Disabled		
CC000-CFFFF Shadow	Disabled		
D0000-D3FFF Shadow	Disabled		
D4000-D7FFF Shadow	Disabled		
D8000-DBFFF Shadow	Disabled		
DC000-DFFFF Shadow	Disabled		

↑↓←→:Move Enter:Select +/-/PU/PD:Value F10:Save ESC:Exit F1:General Help  
F5:Previous Values F6:Fail-Safe Defaults F7:Optimized Defaults

**Virus Warning**

Allows you to choose the VIRUS Warning feature for IDE Hard Disk boot sector protection. If this function is enabled and someone attempt to write data into this area, BIOS will show a warning message on screen and alarm beep.

Enabled	Activates automatically when the system boots up causing a warning message to appear when anything attempts to access the boot sector or hard disk partition table.
Disabled	No warning message will appear when anything attempts to access the boot sector or hard disk partition table.

**! WARNING!**  
Disk boot sector is to be modified  
Type "Y" to accept write or "N" to abort write  
Award Software, Inc.

Note: This function is available only for DOS and other OSes that do not trap INT13.

### **CPU Internal Cache/External Cache**

These two categories speed up memory access. However, it depends on CPU/chipset design. The default value is Enable. If your CPU without Internal Cache then this item "CPU Internal Cache" will not be show.

The Choice: Enabled/Disabled

### **CPU L2 Cache ECC Checking**

This category could turn on the ECC of Pentium III L2 Cache or just disable it.

The Choice: Enabled/Disabled

### **Processor Number Feature**

Intel included a serial number in their Pentium III processors as a unique system identifier. For privacy reasons, you can disable this setting to prevent the release of this identifier.

The Choice: Enabled/Disabled

### **Quick Power On Self Test**

This category speeds up Power On Self Test (POST) after you power on the computer. If it is set to Enable, BIOS will shorten or skip some check items during POST.

The Choice: Enabled/Disabled

### **First / Second / Third Boot Device**

The BIOS attempts to load the operating system from the devices in the sequence selected in these items.

The Choice: Floppy, LS/ZIP, HDD, SCSI, CDROM, Disabled.

### **Boot Other Device**

If all the selected boot devices failed to boot, select **Enabled** the BIOS will try to boot from the other boot devices (in a predefined sequence) which are present but not selected as boot devices in the setup (and hence have not yet been tried for booting). If select **Disabled**, that may be present but not selected as boot devices in setup.

### **Swap Floppy drive**

If the system has two floppy drives, you can swap the logical drive name assignments.

The choice: Enabled/Disabled.

### **Boot Up Floppy Seek**

Seeks disk drives during boot up. Disabling speeds boot up.

The Choice: Enabled/Disabled.

### **Boot Up NumLock Status**

Select power on state for NumLock.

The Choice: Enabled/Disabled.

**Gate A20 Option**

Select if chipset or keyboard controller should control GateA20.

Normal	A pin in the keyboard controller controls GateA20
Fast	Lets chipset control Gate A20

**Typematic Rate Setting**

Key strokes repeat at a rate determined by the keyboard controller. When enabled, the typematic rate and typematic delay can be selected.

The Choice: Enabled/Disabled.

**Typematic Rate (Chars/Sec)**

Sets the number of times a second to repeat a key stroke when you hold the key down.

The Choice: 6, 8, 10, 12, 15, 20, 24, 30

**Typematic Delay (Msec)**

Sets the delay time after the key is held down before it begins to repeat the keystroke.

The Choice: 250, 500, 750, 1000.

**Security Option**

Select whether the password is required every time the system boots or only when you enter setup.

System	The system will not boot and access to Setup will be denied if the correct password is not entered at the prompt.
Setup	The system will boot, but access to Setup will be denied if the correct password is not entered at the prompt.

**Note:** To disable security, select PASSWORD SETTING at Main Menu and then you will be asked to enter password. Do not type anything and just press **<Enter>**, it will disable security. Once the security is disabled, the system will boot and you can enter Setup freely.

**MPS Version control For OS**

This field specifies the version of MPS used by the motherboard.

The Choice: 1.1, 1.4

**OS Select for DRAM > 64MB**

Select the operating system that is running with greater than 64MB of RAM on the system.

The Choice: Non-OS2, OS2

### **HDD S.M.A.R.T. Capability**

S.M.A.R.T. (Self-Monitoring, Analysis and Reporting Technology) is a technology developed to manage the reliability of the hard disk by predicting future device failures. The hard disk needs to be S.M.A.R.T. capable. The settings for this option are Disabled or Enabled.

\* Note: S.M.A.R.T. cannot predict all future device failures. S.M.A.R.T. should be used as a warning tool, not as a tool to predict the device reliability.

The Choice: Enabled/Disabled.

### **Video BIOS Shadow**

It determines whether video BIOS will be copied to RAM, however, it is optional from chipset design. Video Shadow will increase the video speed.

Enabled	Video shadow is enabled
Disabled	Video shadow is disabled

### **C8000 - CFFFF Shadow / D0000 - DFFFF Shadow**

These categories determine whether optional ROM will be copied to RAM by 16K byte or 32K byte per/unit and the size depends on chipset.

Enabled	Optional shadow is enabled
Disabled	Optional shadow is disabled

**Note:** For C8000-DFFFF option-ROM on PCI BIOS , BIOS will automatically enable the shadow RAM. User does not have to select the item.

**Advanced Chipset Features Setup Menu**

Since the features in this section are related to the chipset in the CPU board and all are optimized, you are not recommended to change the default settings in the setup table, unless you know very detailed of the chipset features.

CMOS Setup Utility - Copyright (C) 1984-2000 Award Software  
Advanced Chipset Features

RDRAM Bus Frequency	300 MHz	Item Help
DRAM Data Integrity Mode	Non-ECC	Menu Level ▶
System BIOS Cacheable	Enabled	
Video BIOS Cacheable	Enabled	
Video RAM Cacheable	Disabled	
Memory Hole At 15M-16M	Disabled	
Delayed Transaction	Enabled	
AGP Aperture Size (MB)	64	

↑↓→←:Move Enter:Select +/-/PU/PD:Value F10:Save ESC:Exit F1:General Help  
F5:Previous Values F6:Fail-Safe Defaults F7:Optimized Defaults

This section allows you to configure the system based on the specific features of the installed chipset. This chipset manages bus speeds and access to system memory resources, such as DRAM and the external cache. It also coordinates communications between the conventional ISA bus and the PCI bus. It must be stated that these items should never need to be altered. The default settings have been chosen because they provide the best operating conditions for your system. The only time you might consider making any changes would be if you discovered that data was being lost while using your system.

The first chipset settings deal with CPU access to dynamic random access memory (DRAM). The default timings have been carefully chosen and should only be altered if data is being lost. Such a scenario might well occur if your system had mixed speed DRAM chips installed so that greater delays may be required to preserve the integrity of the data held in the slower memory chips.

**RDRAM Bus Frequency**

This item defines the RDRAM bus frequency.

The Choice: 400MHz, 300MHz

**DRAM Data Integrity Mode**

Select Parity or ECC (error-correcting code), according to the type of installed DRAM.

The Choice: Non-ECC, ECC.

**System BIOS Cacheable**

Selecting Enabled allows caching of the system BIOS ROM at F0000h-FFFFFh, resulting in better system performance. However, if any program writes to this memory area, a system error may result.

The choice: Enabled, Disabled.

**Video BIOS Cacheable**

Select Enabled allows caching of the video BIOS, resulting in better system performance. However, if any program writes to this memory area, a system error may result.

The Choice: Enabled, Disabled.

**Video RAM Cacheable**

Select Enabled allows caching of the video RAM, resulting in better system performance. However, if any program writes to this memory area, a system error may result.

The Choice: Enabled, Disabled.

**Memory Hole At 15M-16M**

In order to improve performance, certain space in memory can be reserved for ISA cards. This memory must be mapped into the memory space below 16 MB.

**Delay Transaction**

The chipset has an embedded 32-bit posted write buffer to support delay transactions cycles. Select Enabled to support compliance with PCI specification version 2.1.

The Choice: Enabled, Disabled.

**AGP Aperture Size (MB)**

Select the size of Accelerated Graphics Port (AGP) aperture. The aperture is a portion of the PCI memory address range dedicated for graphics memory address space. Host cycles that hit the aperture range are forwarded to the AGP without any translation.

The Choice: 4M, 8M, 16M, 32M, 65M, 128M, 256M.

**Integrated Peripherals**

CMOS Setup Utility - Copyright (C) 1984-2000 Award Software  
 Integrated Peripherals

Onboard VGA H/W Active	Enabled	▲ ▼	Item Help
Onboard LAN1 H/W Active	Enabled		Menu Level ▶
Onboard LAN2 H/W Active	Enabled		
Onboard LAN Boot ROM	Disabled		
Onboard SCSI Boot ROM	Enabled		
On-Chip Primary PCI IDE	Enabled		
On-Chip Secondary PCI IDE	Enabled		
IDE Primary Master PIO	Auto		
IDE Primary Slave PIO	Auto		
IDE Secondary Master PIO	Auto		
IDE Secondary Slave PIO	Auto		
IDE Primary Master UDMA	Auto		
IDE Primary Slave UDMA	Auto		
IDE Secondary Master UDMA	Auto		
IDE Secondary Slave UDMA	Auto		
USB Controller	Enabled		
USB Keyboard Support	Disabled		
Init Display First	PCI Slot		
IDE HDD Block Mode	Enabled		
POWER ON Function	Any KEY		
Onboard FDC Controller	Enabled		
Onboard Serial Port 1	3F8/IRQ4		
Onboard Serial Port 2	2F8/IRQ3		
UART Mode Select	Normal		
UR2 Duplex Mode	Half		
TxD, RxD Polarity Active	Lo, Hi		
Onboard Parallel Port	378/IRQ7		
Parallel Port Mode	PRINTER		
ECP Mode Use DMA	3		

↑↓←→:Move Enter:Select +/-/PU/PD:Value F10:Save ESC:Exit F1:General Help  
 F5:Previous Values F6:Fail-Safe Defaults F7:Optimized Defaults

**Onboard VGA/LAN1/LAN2 H/W Active**

Select the enabled if there is a H/W active installed on the system board and you wish to use it.  
 Choice: enable, disabled

**Onboard LAN Boot ROM/SCSI Boot ROM**

Select enabled if you wish to run the LAN Boot Rom/SCSI Boot ROM as boot –up your computer.  
 Choice: enabled, disabled

**On-Chip Primary/Secondary PCI IDE**

The chipset contains a PCI IDE interface with support for two IDE channels. Select Enabled to activate the primary IDE interface. Select Disabled to deactivate this interface

The choice: Enabled, Disabled.

### **IDE Primary/Secondary Master/Slave PIO**

The four IDE PIO (Programmed Input/Output) fields let you set a PIO mode (0-4) for each of the four IDE devices that the onboard IDE interface supports. Modes 0 through 4 provide successively increased performance. In Auto mode, the system automatically determines the best mode for each device.

The choice: Auto, Mode 0, Mode 1, Mode 2, Mode 3 and Mode 4.

### **IDE Primary/Secondary Master/Slave UDMA**

Ultra DMA/33 implementation is possible only if your IDE hard drive supports it and the operating environment includes a DMA driver (Windows 95 OSR2 or a third-party IDE bus master driver). If your hard drive and your system software both support Ultra DMA/33, select Auto to enable BIOS support.

The Choice: Auto, Disabled.

### **USB Controller**

Select *Enabled* if your system contains a Universal Serial Bus (USB) controller and you have USB peripherals.

The choice: Enabled, Disabled.

### **USB Keyboard Support**

Select Enabled if your system contains a Universal Serial Bus (USB) controller and you have a USB keyboard.

The choice: Enabled, Disabled.

### **Init Display First**

This item allows you to decide to active whether PCI Slot or on-chip VGA first

The choice: PCI Slot, Onboard.

### **IDE HDD Block Mode**

Block mode is also called block transfer, multiple commands, or multiple sector read/write. If your IDE hard drive supports block mode (most new drives do), select Enabled for automatic detection of the optimal number of block read/writes per sector the drive can support.

The choice: Enabled, Disabled

### **POWER ON Function**

This item allows you the select power on event.

The choice: Password, Hot Key, Mouse Left, Mouse Right, Any Key, Button Only, Keyboard 98.

**Onboard FDC Controller**

Select Enabled if your system has a floppy disk controller (FDC) installed on the system board and you wish to use it. If you install and-in FDC or the system has no floppy drive, select Disabled in this field.

The choice: Enabled, Disabled.

**Onboard Serial Port 1/Port 2**

Select an address and corresponding interrupt for the first and second serial ports.

The choice: 3F8/IRQ4, 2E8/IRQ3, 3E8/IRQ4, 2F8/IRQ3, Disabled, Auto.

**UART Mode Select**

This item allows you to select UART mode.

The choice: Enabled, Disabled.

**UR2 Duplex Mode**

This item allows you to select the IR half/full duplex function.

The Choice: Half, Full.

**TxD, RxD Polarity Active**

This item allows you to determine the active of.TxD, RxD

The Choice: "Hi, Hi", "Lo, Lo", "Lo, Hi", "Hi, Lo".

**Onboard Parallel Port**

This item allows you to determine access On-Board parallel port controller with which I/O address.

The Choice: 3BC/IRQ7, 378/IRQ7, 278/IRQ5, Disabled.

**Parallel Port Mode**

Select an operating mode for the On-Board parallel (printer) port. Select *Normal*, *Compatible*, or *SPP* unless you are certain your hardware and software both support one of the other available modes.

The Choice: SPP, EPP, ECP, ECP+EPP.

**ECP Mode Use DMA**

Select a DMA channel for the parallel port for use during ECP mode.

The Choice: 3, 1.

**Power Management Setup**

The Power Management Setup allows you to configure you system to most effectively save energy while operating in a manner consistent with your own style of computer use.

CMOS Setup Utility - Copyright (C) 1984-2000 Award Software  
Power Management Setup

ACPI Function	Enabled	▲ ▼	Item Help	
ACPI Suspend Type	S1(POS)		Menu Level ▶	
Power Management	Min Saving			
Video Off Method	DPMS			
Video Off In Suspend	Yes			
Suspend Type	Stop Grant			
MODEM Use IRQ	3			
Suspend Mode	1 Hour			
HDD Power Down	15 Min			
Soft-Off by PWR-BTTN	Instant-Off			
Wake-Up by PCI card	Enabled			
PowerOn by Ring	Enabled			
USB KB Wake-Up From S3	Disabled			
Intruder# Detection	Disabled			
CPU THRM-Throttling	50.0%			
** Reload Global Timer Events **				
Primary IDE 0	Disabled			
Primary IDE 1	Disabled			
Secondary IDE 0	Disabled			
Secondary IDE 1	Disabled			
FDD,COM,LPT Port	Disabled			
PCI PIRQ[A-D]#	Disabled			

↑↓←→:Move Enter:Select +/-/PU/PD:Value F10:Save ESC:Exit F1:General Help  
F5:Previous Values F6:Fail-Safe Defaults F7:Optimized Defaults

**ACPI Function**

This item allows you to enable/disable the Advanced Configuration and Power Management (ACPI).

The choice: Enabled, Disabled.

**ACPI Suspend Type**

Specifies the ACPI suspend type.

The choice: S1 (POS), S3 (STR).

### **Power Management**

This category allows you to select the type (or degree) of power saving and is directly related to the following modes:

1. HDD Power Down
2. Doze Mode
3. Suspend Mode

There are four selections for Power Management, three of which have fixed mode settings.

Disable (default)	No power management. Disables all four modes
Min. Power Saving	Minimum power management. Doze Mode = 1 hr. Standby Mode = 1 hr., Suspend Mode = 1 hr., and HDD Power Down = 15 min.
Max. Power Saving	Maximum power management -- <b>ONLY AVAILABLE FOR SL CPU's</b> . Doze Mode = 1 min., Standby Mode = 1 min., Suspend Mode = 1 min., and HDD Power Down = 1 min.
User Defined	Allows you to set each mode individually. When not disabled, each of the ranges are from 1 min. to 1 hr. except for HDD Power Down which ranges from 1 min. to 15 min. and disable.

### **Video Off Method**

This determines the manner in which the monitor is blanked.

V/H SYNC+Blank	This selection will cause the system to turn off the vertical and horizontal synchronization ports and write blanks to the video buffer.
Blank Screen	This option only writes blanks to the video buffer.
DPMS	Initial display power management signaling.

### **Video Off In Suspend**

This determines the manner in which the monitor is blanked.

The choice: Yes, No.

### **Suspend Type**

Select the Suspend Type.

The choice: PWRON Suspend, Stop Grant.

### **MODEM Use IRQ**

This determines the IRQ in which the MODEM can use.

The choice: 3, 4, 5, 7, 9, 10, 11, NA.

**Suspend Mode**

When enabled and after the set time of system inactivity, all devices except the CPU will be shut off.

The choice: Enabled, Disabled.

**HDD Power Down**

When enabled and after the set time of system inactivity, the hard disk drive will be powered down while all other devices remain active.

The choice: Enabled, Disabled.

**Soft-Off by PWR-BTTN**

Pressing the power button for more than 4 seconds forces the system to enter the Soft-Off state when the system has "hung."

The choice: Delay 4 Sec, Instant-Off.

**Wake-Up by PCI card**

When enabled, you can "wake-up" your system using a PCI rev.2.2 card, when a "PME" event occurring.

The choice: Enabled, Disabled.

**Power On by Ring**

An input signal on the serial Ring Indicator(RI) line (in other words, an incoming call on the modem) awakens the system from a soft off state..

The Choice: Enabled (Default), Disabled.

**USB KB Wake-Up From S3**

This item will enable you to wake up the system by USB Keyboard when you shot down the computer in S3 mode.

The choice: Enabled, Disabled.

**Intruder# Detection**

Intruder Detect: Disables system if box detected open.

**CPU THRM-Throttling**

Select the CPU THRM-Throttling rate.

The choice: 25.0%, 37.5%, 50.0%, 62.5%, 75.0%, 87.5%.

## **Reload Global Timer Events**

PM events are I/O events whose occurrence can prevent the system from entering a power saving mode or can awaken the system from such a mode. In effect, the system remains alert for anything which occurs to a device which is configured as Enabled, even when the system is in a power down mode.

### **IRQ [3-7,9-15], NMI**

If enabled, timer will be reloaded when any of these interrupts occurs.

### **Primary IDE 0**

If enabled, timer will be reloaded when master disk of primary IDE channel is active.

### **IRQ [3-7,9-15], NMI**

If enabled, timer will be reloaded when any of these interrupts occurs.

### **Primary IDE 0**

If enabled, timer will be reloaded when master disk of primary IDE channel is active.

### **Primary IDE 1**

If enabled, timer will be reloaded when slave disk of primary IDE channel is active.

### **Secondary IDE 0**

If enabled, timer will be reloaded when master disk of secondary IDE channel is active.

### **Secondary IDE 1**

If enabled, timer will be reloaded when slave disk of secondary IDE channel is active.

### **Floppy Disk**

If enabled, timer will be reloaded when floppy disk is active.

### **Serial Port**

If enabled, timer will be reloaded when serial port is active.

### **Parallel Port**

If enabled, timer will be reloaded when parallel port is active.

**PnP/PCI Configuration**

This section describes configuring the PCI bus system. PCI, or Peripheral Component Interconnect, is a system which allows I/O devices to operate at speeds nearing the speed the CPU itself uses when communicating with its own special components. This section covers some very technical items and it is strongly recommended that only experienced users should make any changes to the default settings.

CMOS Setup Utility - Copyright (C) 1984-2000 Award Software  
PnP/PCI Configurations

PNP OS Installed	Yes	Item Help
Reset Configuration Data	Disabled	
Resources Controlled By	Auto(ESCD)	Menu Level ▶
× IRQ Resources	Press Enter	Select Yes if you are using a Plug and Play capable operating system Select No if you need the BIOS to configure non-boot devices
× DMA Resources	Press Enter	
× Memory Resources	Press Enter	
PCI/VGA Palette Snoop	Disabled	
Assign IRQ For VGA	Enabled	
Assign IRQ For USB	Enabled	
INT Pin 1 Assignment	Auto	
INT Pin 2 Assignment	Auto	
INT Pin 3 Assignment	Auto	
INT Pin 4 Assignment	Auto	

↑↓←→:Move Enter:Select +/-/PU/PD:Value F10:Save ESC:Exit F1:General Help  
F5:Previous Values F6:Fail-Safe Defaults F7:Optimized Defaults

**PNP OS Installed**

Select **Yes** if the system operating environment is Plug-and-Play aware (e.g. Windows 95).  
The Choice: Yes and No.

**Reset Configuration Data**

Normally, you leave this field Disabled. Select Enabled to reset Extended System Configuration Data (ESCD) when you exit Setup if you have installed a new add-on Card and the system reconfiguration has caused such a serious conflict that the operating system can not boot.  
The choice: Enabled, Disabled .

**Resources Controlled by**

The Award Plug and Play BIOS has the capacity to automatically configure all of the boot and Plug and Play compatible devices. However, this capability means absolutely nothing unless you are using a Plug and Play operating system such as Windows®95. If you set this field to “manual” choose specific resources by going into each of the sub menu that follows this field.  
The Choice: Auto (ESCD), Manual.

**IRQ/DMA Assigned To**

This item allows you to determine the IRQ / DMA assigned to the ISA bus and is not available to any PCI

slot. (Legacy ISA) or PnP for both ISA and PCI.

Choices are *Legacy ISA* and *PCI/ISA PnP*.

### **Memory Resources**

#### **Used MEM Base Addr**

Some add-in cards ask for a specific address space in the system memory. This field specifies the memory base (start address) of the reserved memory space.

The Choice: N/A, C800, CC00, D000, D400, D800, DC00

#### **Used MEM Length**

This item is available only when the Used MEM Base Addr has been assigned a base address. It specifies the memory size for the add-in card used.

The Choice: 8K, 16K, 32K, 64K

### **PCI/VGA Palette Snoop**

Leave this field at Disabled.

The choice: Enabled, Disabled.

### **Assign IRQ For VGA/USB**

Enable/Disable to assign a IRQ for VGA/USB.

Choices are Enabled, Disabled.

**PC Health Status**

CMOS Setup Utility - Copyright (C) 1984-2000 Award Software  
 PC Health Status

Warning Temp. Beep	Enabled	Item Help
CPU Warning Temperature	120	
Current CPU1 Temperature		Menu Level ▶
Current CPU2 Temperature		
Vtt		
+ 3.3V		
+ 5 V		
+12 V		
-12 V	-	
- 5 V	-	
+ 2.5V		
CPU1 Vcore		
CPU2 Vcore		
Current CPUFAN1 Speed		
Current CPUFAN2 Speed		

↑↓←→:Move Enter:Select +/-/PU/PD:Value F10:Save ESC:Exit F1:General Help  
 F5:Previous Values F6:Fail-Safe Defaults F7:Optimized Defaults

**CPU Warning Temperature**

This item will prevent CPU from overheating.

The choice: 30-120.

**Frequency/Voltage Control**

CMOS Setup Utility - Copyright (C) 1984-2000 Award Software  
Frequency/Voltage Control

CPU Clock Ratio            X 3	Item Help
	Menu Level    ▶

↑↓←→: Move    Enter: Select    +/-/PU/PD: Value    F10: Save    ESC: Exit    F1: General Help  
 F5: Previous Values    F6: Fail-Safe Defaults    F7: Optimized Defaults

**CPU Clock Ratio**

This item allows you to set up the CPU clock ratio, but this function depends on different CPU performance. It is only effective for those clock ratio haven't been locked.

The choice: X3.0~X8.0.

### **Supervisor/User Password Setting**

You can set either supervisor or user password, or both of them. The differences between are:

**supervisor password** : can enter and change the options of the setup menus.

**user password** : just can only enter but do not have the right to change the options of the setup menus. When you select this function, the following message will appear at the center of the screen to assist you in creating a password.

#### **ENTER PASSWORD:**

Type the password, up to eight characters in length, and press <Enter>. The password typed now will clear any previously entered password from CMOS memory. You will be asked to confirm the password. Type the password again and press <Enter>. You may also press <Esc> to abort the selection and not enter a password.

To disable a password, just press <Enter> when you are prompted to enter the password. A message will confirm the password will be disabled. Once the password is disabled, the system will boot and you can enter Setup freely.

#### **PASSWORD DISABLED**

When a password has been enabled, you will be prompted to enter it every time you try to enter Setup. This prevents an unauthorized person from changing any part of your system configuration.

Additionally, when a password is enabled, you can also require the BIOS to request a password every time your system is rebooted. This would prevent unauthorized use of your computer.

You determine when the password is required within the BIOS Features Setup Menu and its Security option (see Section 3). If the Security option is set to "System", the password will be required both at boot and at entry to Setup. If set to "Setup", prompting only occurs when trying to enter Setup.

**Power-On Boot**

After you have made all the changes to CMOS values and the system cannot boot with the CMOS values selected in Setup, restart the system by turning it OFF then ON or Pressing the "RESET" button on the system case. You may also restart by simultaneously press **<Ctrl>**, **<Alt>**, and **<Delete>** keys.

Upon restart the system, immediately press **<Insert>** to load BIOS default CMOS value for boot up.

## 4-2 BIOS Reference - POST Message

During the Power On Self Test (POST), if the BIOS detects an error requiring you to do something to fix, it will either sound a beep code or display a message.

If a message is displayed, it will be accompanied by:

**PRESS <F1> TO CONTINUE, <CTRL>-<ALT>-<ESC> OR <DEL> TO ENTER SETUP**

### **POST Beep**

Currently there is only one beep code in BIOS. This code indicates that a video error has occurred and the BIOS cannot initialize the video screen to display any additional information. This beep code consists of a single long beep followed by two short beeps.

### **Error Messages**

One or more of the following messages may be displayed if the BIOS detects an error during the POST. This list includes messages for both the ISA and the EISA BIOS.

#### **BIOS ROM checksum error-System halted.**

The checksum of ROM address F0000H-FFFFFH is bad.

#### **CMOS BATTERY HAS FAILED**

CMOS battery is no longer functional. It should be replaced.

#### **CMOS CHECKSUM ERROR**

Checksum of CMOS is incorrect. This can indicate that CMOS has become corrupt. This error may have been caused by a weak battery. Check the battery and replace if necessary.

#### **DISK BOOT FAILURE, INSERT SYSTEM DISK AND PRESS ENTER**

No boot device was found. This could mean that either a boot drive was not detected or the drive does not contain proper system boot files. Insert a system disk into Drive A: and press <Enter>. If you assumed the system would boot from the hard drive, make sure the controller is inserted correctly and all cables are properly attached. Also be sure the disk is formatted as a boot device. Then reboot the system.

#### **DISKETTE DRIVES OR TYPES MISMATCH ERROR - RUN SETUP**

Type of diskette drive installed in the system is different from the CMOS definition. Run Setup to reconfigure the drive type correctly.

#### **DISPLAY SWITCH IS SET INCORRECTLY**

Display switch on the motherboard can be set to either monochrome or color. This indicates the switch is set to a different setting than indicated in Setup. Determine which setting is correct, and then either turn off the system and change the jumper, or enter Setup and change the VIDEO selection.

**DISPLAY TYPE HAS CHANGED SINCE LAST BOOT**

Since last powering off the system, the display adapter has been changed. You must configure the system for the new display type.

**EISA Configuration Checksum Error  
PLEASE RUN EISA CONFIGURATION UTILITY**

The EISA non-volatile RAM checksum is incorrect or cannot correctly read the EISA slot. This can indicate either the EISA non-volatile memory has become corrupt or the slot has been configured incorrectly. Also be sure the card is installed firmly in the slot.

**EISA Configuration Is Not Complete  
PLEASE RUN EISA CONFIGURATION UTILITY**

The slot configuration information stored in the EISA non-volatile memory is incomplete.

Note: When either of these errors appear, the system will boot in ISA mode, which allows you to run the EISA Configuration Utility.

**ERROR ENCOUNTERED INITIALIZING HARD DRIVE**

Hard drive cannot be initialized. Be sure the adapter is installed correctly and all cables are correctly and firmly attached. Also be sure the correct hard drive type is selected in Setup.

**ERROR INITIALIZING HARD DISK CONTROLLER**

Cannot initialize controller. Make sure the cord is correctly and firmly installed in the bus. Be sure the correct hard drive type is selected in Setup. Also check to see if any jumper needs to be set correctly on the hard drive.

**FLOPPY DISK CNTRLR ERROR OR NO CNTRLR PRESENT**

Cannot find or initialize the floppy drive controller. make sure the controller is installed correctly and firmly. If there are no floppy drives installed, be sure the Diskette Drive selection in Setup is set to NONE.

**FLOOPY DISK(S) fail (80)**

Unable to reset floppy subsystem.

**FLOOPY DISK(S) fail (40)**

Floppy Type mismatch.

**Hard Disk(s) fail (80)**

HDD reset failed

**Hard Disk(s) fail (40)**

HDD controller diagnostics failed.

**Hard Disk(s) fail (20)**

HDD initialization error.

**Hard Disk(s) fail (10)**

Unable to recalibrate fixed disk.

**Hard Disk(s) fail (08)**

Sector Verify failed.

**Invalid EISA Configuration****PLEASE RUN EISA CONFIGURATION UTILITY**

The non-volatile memory containing EISA configuration information was programmed incorrectly or has become corrupt. Re-run EISA configuration utility to correctly program the memory.

NOTE: When this error appears, the system will boot in ISA mode, which allows you to run the EISA Configuration Utility.

**KEYBOARD ERROR OR NO KEYBOARD PRESENT**

Cannot initialize the keyboard. Make sure the keyboard is attached correctly and no keys are being pressed during the boot.

If you are purposely configuring the system without a keyboard, set the error halt condition in Setup to HALT ON ALL, BUT KEYBOARD. This will cause the BIOS to ignore the missing keyboard and continue the boot.

**Keyboard is locked out-Unlock the key**

BIOS detect the keyboard is locked. P17 of keyboard controller is pulled low.

**Manufacturing POST loop**

System will repeat POST procedure infinitely while the P15 of keyboard controller is pull low. This is also used for M/B burn in test.

**Memory Address Error at ...**

Indicates a memory address error at a specific location. You can use this location along with the memory map for your system to find and replace the bad memory chips.

**Memory test fail**

BIOS reports the memory test fail if the onboard memory is tested error.

**Memory parity Error at ...**

Indicates a memory parity error at a specific location. You can use this location along with the memory map for your system to find and replace the bad memory chips.

**MEMORY SIZE HAS CHANGED SINCE LAST BOOT**

Memory has been added or removed since the last boot. In EISA mode use Configuration Utility to reconfigure the memory configuration. In ISA mode enter Setup and enter the new memory size in the memory fields.

**Memory Verify Error at ...**

Indicates an error verifying a value already written to memory. Use the location along with your system's memory map to locate the bad chip.

**OFFENDING ADDRESS NOT FOUND**

This message is used in conjunction with the I/O CHANNEL CHECK and RAM PARITY ERROR messages when the segment that has caused the problem cannot be isolated.

**OFFENDING SEGMENT:**

This message is used in conjunction with the I/O CHANNEL CHECK and RAM PARITY ERROR messages when the segment that has caused the problem has been isolated.

**PRESS A KEY TO REBOOT**

This will be displayed at the bottom screen when an error occurs that requires you to reboot. Press any key and the system will reboot.

**PRESS F1 TO DISABLE NMI, F2 TO REBOOT**

When BIOS detects a Non-maskable Interrupt condition during boot, this will allow you to disable the NMI and continue to boot, or you can reboot the system with the NMI enabled.

**RAM PARITY ERROR - CHECKING FOR SEGMENT ...**

Indicates a parity error in Random Access Memory.

**Should Be Empty But EISA Board Found  
PLEASE RUN EISA CONFIGURATION UTILITY**

A valid board ID was found in a slot that was configured as having no board ID.

NOTE: When this error appears, the system will boot in ISA mode, which allows you to run the EISA Configuration Utility.

**Should Have EISA Board But Not Found  
PLEASE RUN EISA CONFIGURATION UTILITY**

The board installed is not responding to the ID request, or no board ID has been found in the indicated slot.

NOTE: When this error appears, the system will boot in ISA mode, which allows you to run the EISA Configuration Utility.

**Slot Not Empty**

Indicates that a slot designated as empty by the EISA Configuration Utility actually contains a board.

NOTE: When this error appears, the system will boot in ISA mode, which allows you to run the EISA Configuration Utility.

**SYSTEM HALTED, (CTRL-ALT-DEL) TO REBOOT ...**

Indicates the present boot attempt has been aborted and the system must be rebooted. Press and hold down the CTRL and ALT keys and press DEL.

**Wrong Board In Slot  
PLEASE RUN EISA CONFIGURATION UTILITY**

The board ID does not match the ID stored in the EISA non-volatile memory.

NOTE: When this error appears, the system will boot in ISA mode, which allows you to run the EISA Configuration Utility.

**4-3 BIOS Reference - POST Codes**

POST (hex)	Description
CFh	Test CMOS R/W functionality.
C0h	Early chipset initialization: -Disable shadow RAM -Disable L2 cache (socket 7 or below) -Program basic chipset registers
C1h	Detect memory -Auto-detection of DRAM size, type and ECC. -Auto-detection of L2 cache (socket 7 or below)
C3h	Expand compressed BIOS code to DRAM
C5h	Call chipset hook to copy BIOS back to E000 & F000 shadow RAM.
0h1	Expand the Xgroup codes locating in physical address 1000:0
02h	Reserved
03h	Initial Superio_Early_Init switch.
04h	Reserved
05h	1. Blank out screen 2. Clear CMOS error flag
06h	Reserved
07h	1. Clear 8042 interface 2. Initialize 8042 self-test
08h	1. Test special keyboard controller for Winbond 977 series Super I/O chips. 2. Enable keyboard interface.
09h	Reserved
0Ah	1. Disable PS/2 mouse interface (optional). 2. Auto detect ports for keyboard & mouse followed by a port & interface swap (optional). 3. Reset keyboard for Winbond 977 series Super I/O chips.
0Bh	Reserved
0Ch	Reserved
0Dh	Reserved
0Eh	Test F000h segment shadow to see whether it is R/W-able or not. If test fails, keep beeping the speaker.
0Fh	Reserved
10h	Auto detect flash type to load appropriate flash R/W codes into the run time area in F000

POST (hex)	Description
	for ESCD & DMI support.
11h	Reserved
12h	Use walking 1's algorithm to check out interface in CMOS circuitry. Also set real-time clock power status, and then check for override.
13h	Reserved
14h	Program chipset default values into chipset. Chipset default values are MODBINable by OEM customers.
15h	Reserved
16h	Initial Early_Init_Onboard_Generator switch.
17h	Reserved
18h	Detect CPU information including brand, SMI type (Cyrix or Intel) and CPU level (586 or 686).
19h	Reserved
1Ah	Reserved
1Bh	Initial interrupts vector table. If no special specified, all H/W interrupts are directed to SPURIOUS_INT_HDLR & S/W interrupts to SPURIOUS_soft_HDLR.
1Ch	Reserved
1Dh	Initial EARLY_PM_INIT switch.
1Eh	Reserved
1Fh	Load keyboard matrix (notebook platform)
20h	Reserved
21h	HPM initialization (notebook platform)
22h	Reserved
23h	<ol style="list-style-type: none"> <li>1. Check validity of RTC value: e.g. a value of 5Ah is an invalid value for RTC minute.</li> <li>2. Load CMOS settings into BIOS stack. If CMOS checksum fails, use default value instead.</li> <li>3. Prepare BIOS resource map for PCI &amp; PnP use. If ESCD is valid, take into consideration of the ESCD's legacy information.</li> <li>4. Onboard clock generator initialization. Disable respective clock resource to empty PCI &amp; DIMM slots.</li> <li>5. Early PCI initialization: <ul style="list-style-type: none"> <li>-Enumerate PCI bus number</li> <li>-Assign memory &amp; I/O resource</li> <li>-Search for a valid VGA device &amp; VGA BIOS, and put it into C000:0.</li> </ul> </li> </ol>

POST (hex)	Description
24h	Reserved
25h	Reserved
26h	Reserved
27h	Initialize INT 09 buffer
28h	Reserved
29h	<ol style="list-style-type: none"> <li>1. Program CPU internal MTRR (P6 &amp; PII) for 0-640K memory address.</li> <li>2. Initialize the APIC for Pentium class CPU.</li> <li>3. Program early chipset according to CMOS setup. Example: onboard IDE controller.</li> <li>4. Measure CPU speed.</li> <li>5. Invoke video BIOS.</li> </ol>
2Ah	Reserved
2Bh	Reserved
2Ch	Reserved
2Dh	<ol style="list-style-type: none"> <li>1. Initialize multi-language</li> <li>2. Put information on screen display, including Award title, CPU type, CPU speed ....</li> </ol>
2Eh	Reserved
2Fh	Reserved
30h	Reserved
31h	Reserved
32h	Reserved
33h	Reset keyboard except Winbond 977 series Super I/O chips.
34h	Reserved
35h	Reserved
36h	Reserved
37h	Reserved
38h	Reserved
39h	Reserved
3Ah	Reserved
3Bh	Reserved
3Ch	Test 8254
3Dh	Reserved
3Eh	Test 8259 interrupt mask bits for channel 1.
3Fh	Reserved

POST (hex)	Description
40h	Test 8259 interrupt mask bits for channel 2.
41h	Reserved
42h	Reserved
43h	Test 8259 functionality.
44h	Reserved
45h	Reserved
46h	Reserved
47h	Initialize EISA slot
48h	Reserved
49h	1. Calculate total memory by testing the last double word of each 64K page. 2. Program write allocation for AMD K5 CPU.
4Ah	Reserved
4Bh	Reserved
4Ch	Reserved
4Dh	Reserved
4Eh	1. Program MTRR of M1 CPU 2. Initialize L2 cache for P6 class CPU & program CPU with proper cacheable range. 3. Initialize the APIC for P6 class CPU. 4. On MP platform, adjust the cacheable range to smaller one in case the cacheable ranges between each CPU are not identical.
4Fh	Reserved
50h	Initialize USB
51h	Reserved
52h	Test all memory (clear all extended memory to 0)
53h	Reserved
54h	Reserved
55h	Display number of processors (multi-processor platform)
56h	Reserved
57h	1. Display PnP logo. 2. Early ISA PnP initialization -Assign CSN to every ISA PnP device.
58h	Reserved
59h	Initialize the combined Trend Anti-Virus code.

POST (hex)	Description
5Ah	Reserved
5Bh	(Optional Feature) Show message for entering AWDFLASH.EXE from FDD (optional)
5Ch	Reserved
5Dh	1. Initialize Init_Onboard_Super_IO switch. 2. Initialize Init_Onboard_AUDIO switch.
5Eh	Reserved
5Fh	Reserved
60h	Okay to enter Setup utility; i.e. not until this POST stage can users enter the CMOS setup utility.
61h	Reserved
62h	Reserved
63h	Reserved
64h	Reserved
65h	Initialize PS/2 Mouse
66h	Reserved
67h	Prepare memory size information for function call: INT 15h ax=E820h
68h	Reserved
69h	Turn on L2 cache
6Ah	Reserved
6Bh	Program chipset registers according to items described in Setup & Auto-configuration table.
6Ch	Reserved
6Dh	1. Assign resources to all ISA PnP devices. 2. Auto assign ports to onboard COM ports if the corresponding item in Setup is set to "AUTO".
6Eh	Reserved
6Fh	1. Initialize floppy controller 2. Set up floppy related fields in 40:hardware.
70h	Reserved
71h	Reserved
72h	Reserved
73h	(Optional Feature)

POST (hex)	Description
	Enter AWDFLASH.EXE if : -AWDFLASH is found in floppy drive. -ALT+F2 is pressed
74h	Reserved
75h	Detect & install all IDE devices: HDD, LS120, ZIP, CDROM.....
76h	Reserved
77h	Detect serial ports & parallel ports.
78h	Reserved
79h	Reserved
7Ah	Detect & install co-processor
7Bh	Reserved
7Ch	Reserved
7Dh	Reserved
7Eh	Reserved
7Fh	1. Switch back to text mode if full screen logo is supported. -If errors occur, report errors & wait for keys -If no errors occur or F1 key is pressed to continue: 2. Clear EPA or customization logo.
80h	Reserved
81h	Reserved
<b>E8POST.ASM starts</b>	
82h	1. Call chipset power management hook. 2. Recover the text font used by EPA logo (not for full screen logo) 3. If password is set, ask for password.
83h	Save all data in stack back to CMOS
84h	Initialize ISA PnP boot devices
85h	1. USB final Initialization 2. NET PC: Build SYSID structure 3. Switch screen back to text mode 4. Set up ACPI table at top of memory. 5. Invoke ISA adapter ROMs 6. Assign IRQs to PCI devices 7. Initialize APM

POST (hex)	Description
	8. Clear noise of IRQs.
86h	Reserved
87h	Reserved
88h	Reserved
89h	Reserved
90h	Reserved
91h	Reserved
92h	Reserved
93h	Read HDD boot sector information for Trend Anti-Virus code
94h	<ol style="list-style-type: none"> <li>1. Enable L2 cache</li> <li>2. Program boot up speed</li> <li>3. Chipset final initialization.</li> <li>4. Power management final initialization</li> <li>5. Clear screen &amp; display summary table</li> <li>6. Program K6 write allocation</li> <li>7. Program P6 class write combining</li> </ol>
95h	<ol style="list-style-type: none"> <li>1. Program daylight saving</li> <li>2. Update keyboard LED &amp; typematic rate</li> </ol>
96h	<ol style="list-style-type: none"> <li>1. Build MP table</li> <li>2. Build &amp; update ESCD</li> <li>3. Set CMOS century to 20h or 19h</li> <li>4. Load CMOS time into DOS timer tick</li> <li>5. Build MSIRQ routing table.</li> </ol>
FFh	Boot attempt (INT 19h)

## **Appendix**

### ***Appendix A Watch Dog Timer***

#### **Watch Dog Timer Working Procedure**

The Watch Dog Timer (WDT) is the special hardware device. The WDT function is to monitor the computer system whether work normally, otherwise, it will have some measures to fix up the system.

It contains a receivable SQW signal from RTC, and could set time and can clear the counter function. When time is up, WDT can send Reset or NMI signal.

Operator has to write a value into WDT Configuration Register (Write the control value to the Configuration Port), and clear WDT counter (read the Configuration Port).

#### **Watch Dog Timer character and function**

WDT Configuration port	F2	Default at F2
Watch Dog Timer	Disabled	1. Default at disabled
	Enabled	2. Enabled for user's programming
WDT Time out active for	Reset NMI	Default at Reset
WDT Active Time	1 sec 2 sec 4 sec 8 sec 16 sec 32 sec 64 sec	Default at 64 sec

**Watch Dog Timer Control Register**

The Watch Dog Timer Control Register is to control the WDT working mode. You can write the value to WDT Configuration Port.

The following is the Control Register bit definition.

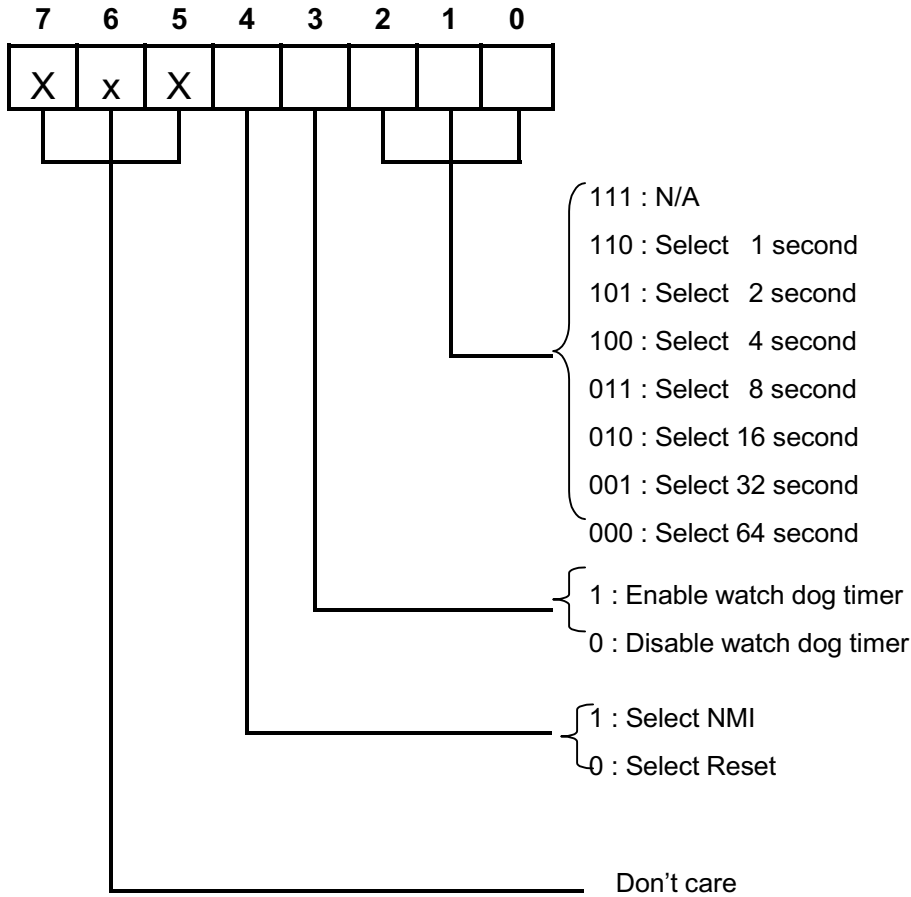

## **Watch Dog Timer Programming Procedure**

### • **Power on or reset the system**

The initial value of WDT Control Register (D4~D0) is zero, when power is on or reset the system. The following means the initial value of WDT ( 00000000b ) :

Bit	Value	Mean
4	0	Select Reset
3	0	Disable watch dog timer
2, 1, 0	0 0 0	Select 64 second

### • **Initialize the SQW of RTC (set SQW output period=0.5 second)**

To initialize the SQW of RTC processor is to set the SQW signal which is output period=0.5 second. It offers the basic frequency of the WDT counter.

The following is an example of **initializing the SQW signal program** in Intel 8086 assembly language.

```

; (Generate SQW = 0.5 Sec.)
Mov  dx, 70h
      Mov    ax, 0Ah
      Out    dx, al          ; Out port 70h = 0Ah
      Mov    dx, 71h
      Mov    ax, 2Fh
      Out    dx, al          ; Out port 71h = 2Fh
; (enable the SQW output)
Mov  dx, 70h
      Mov    ax, 0Bh
      Out    dx, al          ; Out port 70h = 0Bh
      Mov    dx, 71h
      Mov    ax, 0Ah
      Out    dx, al          ; Out port 71h = 0Ah

```

### • Clear the WDT

Repeatedly read WDT Configuration Port and the interval cannot be longer than the preset time, otherwise, the WDT will generate NMI or Reset signal for the system.

The following is an example of **clear the WDT program** in Intel 8086 assembly language.

```

; ( Clear the WDT)
Mov  dx, F2h ;Setting the WDT configuration port
In   al, dx

```

**Note:** Before running WDT, you must clear the WDT. It means to make sure the initial value is zero before enabling the WDT.

### • WDT Control Register (Write to WDT configuration port)

You can set the WDT Control Register to control the WDT working mode.

The initial value of the WDT Control Register is as the following.

```

; (Setting the WDT Control Register as AL)
Mov  al, 0h ; Setting initial value = 0 for the WDT Control Register

```

You must plan the option of following:

1. Select NMI or Reset: decide D4 value in F2.

i.e. Setting D4 = 0, then it select Reset

```

AND  al, 11101111b ; Select Reset

```

i.e. Setting D4 = 1, then it select NMI

```

OR   al, 00010000b ; Select NMI

```

2. Select the time-out intervals of WDT (decide the values of D2, D1, D0 in F2 )

Example: D2~D0 = 0, the time-out interval will be 64 sec.

```

AND  al, 11111000b ; Setting the time-out interval as 64 sec.

```

3. Enable or Disable the WDT ( decide D3 value in F2)

i.e. D3=0, Disable the WDT

```

AND  al, 11110111b ; Disable the WDT

```

i.e. D3=1, Enable the WDT

```

OR   al, 00001000b ; Enable the WDT

```

After finishing the above setting, you must be output for the Control Register's value to the WDT Configuration Port. Then WDT will start according to the above setting.

<pre><b>MOV dx, F2h ; Setting WDT Configuration Port</b></pre>
<pre><b>OUT dx, al ; Output the Control Register Value</b></pre>

You should build in a mechanism in the program to continue to read the WDT Configuration Port for clearing WDT before the time out.

This page is intentionally left blank.